



WE MADE THAT

savills

feasibility

Architecture & Urbanism (Lead)

Property advice

Quantity Surveyors

INDUSTRIAL INTENSIFICATION AND CO-LOCATION STUDY:
DESIGN AND DELIVERY TESTING

05-10-2018

CONTENTS

05-10-2018

1.0 Introduction p 3

1.1	Purpose of the study	3
1.2	Project team	3
1.3	Methodology	3
1.4	Changing policy context	3

2.0 Defining & Measuring Industrial Intensification p 4

2.1	Policy review	4
2.2	Defining intensification	5
2.3	Measures of intensification	7
2.4	Conclusion	10

3.0 Industrial specification p 11

3.1	Occupier/ typology categorisation	11
3.2	Requirements for industrial space	12
3.3	Additional design considerations	18

4.0 Urban scale guidance p 19

4.1	Site layout and frontage	19
4.2	Movement	20
4.3	Access, yards, servicing and parking	20
4.4	Amenity space	21
4.5	Adjacencies	21

5.0 Model sites p 22

5.1	Site selection and method	22
5.2	Approach to model sites	23
5.3	Area 1 Inner London	25
5.4	Model site 1A	26
5.5	Model site 1B	32
5.6	Area 2 Suburban London	38
5.7	Model site 2	39
5.8	Area 2 Urban London	45
5.9	Model site 3	46

6.0 Viability results p 52

6.1	Introduction	52
6.2	Methodology	52
6.3	Scheme appraisals	52
6.4	Assumptions	53
6.5	Site specific viability results	55
6.6	Generalised viability results	64
6.7	Conclusions	74

Appendices p 77

Market stakeholder feedback	78
Build costs	79
Structural guidance	80

1.0

INTRODUCTION

1.1 Purpose of the study

The Greater London Authority (GLA) has commissioned this Industrial Intensification Study to provide guidance on the acceptability of industrial intensification and co-location with residential, and to test the viability and deliverability of various proposals following this guidance.

The study comprises of five key tasks:

- Task A: Defining and Measuring Industrial Intensification, to help inform the implementation of planning policies and the assessment of planning applications.
- Task B: Specifications and Construction Costs, to provide definitions of industrial space specifications, to ensure industrial intensification and co-location with residential, results in genuinely “industrial” space.
- Task C: Urban Scale Guidance, to provide guidance on the development of industrial intensification and associated co-location with residential, beyond the individual site boundary.
- Task D: Testing Proposals, to test the broad viability of industrial intensification in London.
- Task E: Deliverability Commentary, to provide general commentary on wider deliverability issues and potential barriers to delivery, as well as any opportunities for market actors or requirement for public sector intervention of various kinds

1.2 Project team

The team is led by architecture and urbanism practice, We Made That with property and viability advice from Savills and sector specific cost advice from Feasibility.

Established in 2006, We Made That is an energetic architecture and urbanism practice with a strong public conscience. They work with public sector clients to prepare incisive urban research, to develop responsive area strategies and masterplans and to deliver distinctive architecture and public realm projects.

Savills is a global real estate service provider listed on the London Stock Exchange. Their National Industrial and Logistics team provide expertise in a range of service lines for industrial property including corporate real estate, funding, investment, planning and development, building consultancy, project management and lease consultancy. They work with most of the key investors and developers of industrial space in the UK including Baytree, Chancerygate, Goodman, IDI Gazeley, Prologis, and SEGRO.

Feasibility Limited provides expert commercial cost planning and procurement advice to a number of industrial property development companies. They are actively involved in helping to create cost effective solutions to provide the sustainable construction that will be required by developers and occupiers alike in the years ahead.

1.3 Methodology

The study follows the format of the five tasks described above. Tasks D and E are structured around four designed proposals, each set in a specific ‘model site’, which has been selected to be representative of segments of the wider London market. Conclusions from these exercises are therefore intended to provide insight into the opportunities and challenges of industrial intensification at a London-wide scale.

1.4 Changing policy context

The key context of this study is the new London Plan. The policy position of this document reflects a new attitude towards London’s Strategic Industrial Locations and Locally Significant Industrial Sites; changing from a process of managed release, to a stated requirement for “no net loss of industrial floorspace”. The ‘no net loss’ position is defined against the existing industrial floorspace on a site, or a 65% plot ratio, whichever is greater. This policy context and the detail of its application is explored in more detail in Section 2 of this report: ‘Defining & Measuring Industrial Intensification’.

2.0 DEFINING AND MEASURING INDUSTRIAL INTENSIFICATION

2.1 Policy review

The new draft London Plan (2017) sets out a number of new policy ambitions in relation to London's industrial land and industrial capacity. Crucially, the Plan indicates a shift to an ambition of retention of London's industrial capacity, with an overall aim for no net loss of industrial capacity in designated industrial areas across London. This ambition is nuanced across London, with different boroughs identified for retention, additional provision or limited release of industrial floorspace capacity.

A number of queries into the wording and implications of these new draft policies have informed this study's approach and final outputs:

1. Is intensification intended to be delivered and measured on a site-by-site basis, at the Borough level or at the London-wide level?

The scale at which industrial intensification is intended to be delivered and monitored is not restricted to a particular scale. If an industrial site comes forward for development in isolation (i.e. not as part of an area-wide plan), the site scale is appropriate for evaluating whether or not intensification has been achieved. If a site is developed as part of a plan-led approach (e.g. a Local Plan or a masterplan), the plan area is an appropriate scale of assessment for intensification. It is expected that this would normally cover at least the whole of a SIL or LSIS. This allows for some sites to 'take on' the industrial floorspace capacity of neighbouring sites and potentially 'free up' other sites in the area for non-industrial redevelopment.

2. If intensification is to be measured by floorspace plus operational yard space, what is the existing baseline? How to handle shift away from land to floorspace quantum?

The (2016) baseline for industrial floorspace at the London level and borough level is provided by the Valuation Office (commercial floorspace statistics). Industrial floorspace change can be monitored through the London Development Database (LDD). There is no existing baseline for operational yard space at either the Borough or London-wide scale, so any measures of this element of industrial capacity would only be achieved on a site-by-

site basis having regard to site specific operational requirements.

3. What is the motivation for the inclusion of the 'operational yard space' term?
Industrial land audits, design studies and engagement with industrial occupiers and developers has underlined the importance of yard space for industrial businesses to meet their varied operational, servicing and storage requirements, and this element needs to be considered as part of every industrial intensification scheme.

4. How were methods of intensification listed in Policy E7 identified?

Policy E7 lists a number of possible methods for intensifying business uses in B1c, B2 and B8 use classes, including multi-storey development, addition of smaller units or the addition of basements. These methods are not intended to be exhaustive but are rather illustrative of how intensification is envisioned to be floorspace-led.

Key findings:

- The 'no net loss' of industrial floorspace target is applicable to designated industrial land only, and can be interpreted at site-specific, planned area or London-wide level.
- New draft policies signal a shift away from industrial land (hectares) to industrial floorspace (sqm) as a key measure.
- Draft policies foreground spatial measures for delivering industrial intensification.
- Intensification is to be measured through industrial floorspace capacity, which is defined as existing industrial (B1c, B2, B8) floorspace quantum OR floorspace equivalent to 65% plot ratio* of the site (whichever is greater).

*Plot Ratio = Total Gross Floorspace / Total Site Area

Draft new London Plan:

Policy E7 Intensification, co-location and substitution of land for industry, logistics and services to support London's economic function

- A** Development Plans and development proposals should be proactive and encourage the intensification of business uses in Use Classes B1c, B2 and B8 occupying all categories of industrial land through:
- 1) development of mezzanines
 - 2) introduction of small units
 - 3) development of multi-storey schemes
 - 4) addition of basements
 - 5) more efficient use of land through higher plot ratios having regard to operational requirements (including servicing) and mitigating impacts on the transport network where necessary.
- B** Development Plans and planning frameworks should be proactive and consider, in collaboration with the Mayor, whether certain logistics, industrial and related functions in selected parts of SILs could be intensified. Intensification should facilitate the consolidation of the identified SIL to support the delivery of residential and other uses, such as social infrastructure, or to contribute to town centre renewal. This process must meet the criteria set out in part E below and ensure that it does not undermine or compromise the integrity or effectiveness of the SIL in accommodating the industrial-type activities identified in part C of Policy E5 Strategic Industrial Locations (SIL). This approach should only be considered as part of a plan-led process of SIL intensification and consolidation (and the areas affected clearly defined in Development Plan policies maps) or as part of a co-ordinated masterplanning process in collaboration with the GLA and relevant borough, and not through ad hoc planning applications.

Mixed-use development proposals on Non-Designated Industrial Sites which co-locate industrial, storage or distribution floorspace with residential and/or other uses should also meet the criteria set out in parts E.2 to E.4 below.

- E** The processes set out in Parts B, C and D above must ensure that:
- 1) the industrial uses within the SIL or LSIS are intensified to deliver an increase (or at least no overall net loss) of capacity in terms of industrial, storage and warehousing floorspace with appropriate provision of yard space for servicing
 - 2) the industrial and related activities on-site and in surrounding parts of the SIL, LSIS or Non-Designated Industrial Site are not compromised in terms of their continued efficient function, access,

works should be proactive and industrial and related functions intensified and/or co-located with social infrastructure, or to contribute to town centre renewal. This process must meet the criteria set out in part E below and ensure that it does not undermine or compromise the integrity or effectiveness of the SIL in accommodating the industrial-type activities identified in part C of Policy E5 Strategic Industrial Locations (SIL). This approach should only be considered as part of a plan-led process of SIL intensification and consolidation (and the areas affected clearly defined in Development Plan policies maps) or as part of a co-ordinated masterplanning process in collaboration with the GLA and relevant borough, and not through ad hoc planning applications.

proposals on Non-Designated

the site being used for the industrial purposes of Policy E4 Land for industry, logistics and services to support London's economic function; or as part of a co-ordinated masterplanning process in collaboration with the GLA and relevant borough, and not through ad hoc planning applications.

space is provided as part of a plan-led process of SIL intensification and consolidation (and the areas affected clearly defined in Development Plan policies maps) or as part of a co-ordinated masterplanning process in collaboration with the GLA and relevant borough, and not through ad hoc planning applications.

in terms of type, specification, location and proximity to the development of new development.

2.2 Defining intensification

In order to test the application of the new draft London Plan policies, there are a number of key concepts and measures to define:

Floorspace capacity

Floorspace capacity is defined as existing industrial and warehousing floorspace on site or the potential industrial and warehousing floorspace that could be accommodated on the site at a 65% plot ratio (whichever is greater). This includes ancillary floorspace (e.g. office space) which is being used by a given occupier in support of their core (industrial) business activities.

Non-industrial floorspace (e.g. B1A, A and D use classes) which is accommodated on a designated industrial site and is not in use in support of an industrial activity (e.g. standalone offices, retail, leisure etc, tenanted by a non-industrial business) is not included in the industrial floorspace calculation, but is to be included in the potential industrial floorspace calculation that could be accommodated on the site at a 65% plot ratio.

Plot ratio

Plot ratio is defined as the gross floor area (GFA) on a given site, divided by the total site area. The total quantity of floorspace used in this calculation is gross floorspace across all floors.

Plot coverage

Plot coverage is defined as the total building footprint on a given site, divided by the total site area. The quantity of floorspace used in this equation is the total of the floorspace at ground floor level only.

Operational yard space

Operational yard space is defined as the external space needed by a given industrial occupier for their core business activities. This space is typically provided by a yard (covered or uncovered) and is often used for storage, production or processing activities which directly support a business' primary activity. This includes servicing and circulation space for vehicles which enable the movement of goods related to the core business activity.

Operational yard space can be calculated as follows:

- Total site area
- Building footprint
- Parking (staff & customer)
- Green and other open (amenity) space
- Deadspace* (redundant & required)
- = Operational yard space

Operational yard space is calculated as total quantum of site, not per unit.

Illustrative examples of operational yard space are provided alongside. The quantum of external space which remains within the site boundary after discounting the elements listed above (shaded in the examples alongside) is the quantum of operational yard space on that site.

*Redundant deadspace defined as verges, non-accessible open space, areas behind fencing and dimensionally inaccessible spaces, and required deadspace defined as exclusion zones for safety eg. power lines, explosions and insurance.



Example 1: Waxlow Road
Site type: Standalone warehouse
Individual occupier



Example 2: Origin Industrial Park
Site type: Industrial estate
Multiple occupiers

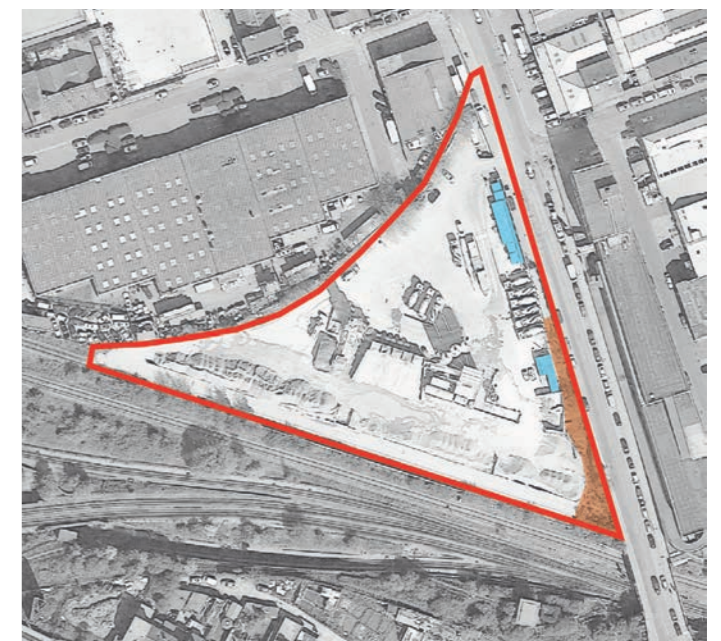

Example 3: Park Royal Road
Site type: Open industrial land
Individual occupier

Key

- Site boundary
- Discounted area (building footprints)
- Discounted external space (parking, green space or deadspace)

Intensification 'rules' testing

Using the definitions established above, a series of different potential intensification 'rules' have been tested in order to understand the practical implications of the draft London Plan industrial intensification policies. In particular, these tests sought to explore the following:

- Does the 65% floorspace capacity measure favour certain site types / typologies of industrial floorspace in intensification efforts?
- What is the implication of the 65% floorspace capacity measure on vacant sites?
- Given demolition processes (possible outside of the planning process unless in Conversation Area), does the current definition of floorspace capacity encourage demolition?
- What is the implication of the floorspace capacity measure for yard-based operations like plant hire, aggregates, vehicle repair etc.?
- Does floorspace capacity measure (65% plot ratio) incentivise inefficient sites, vacant sites and sites with older stock all to produce the same typology?

The following 'rules' were tested:

A. Proposed GFA \geq Existing GFA

B. Proposed GFA + yard space \geq Existing GFA + yard space

C. Proposed GFA by use class \geq Existing GFA by use class

These test examples purposely aim to explore how the policy wording in the draft London Plan might be inadvertently encouraging certain uses / classes, on the basis of the assumption that typically B1c is easier to stack than B2 or B8 uses due to lower floor loading and shorter clear span requirements. Market feedback also suggests occupiers of B1c are more likely to be flexible to stacking. Overall, an assumption has been made in favour of single-storey re-provision where possible as it is expected that most developers will preference single-storey development over stacked delivery given the costs / technical implications. This is not to discount existing and proposed examples of multi-storey B2 and B8, which are of course possible, but rather the purposely test how the current policy wording could be interpreted.

Key findings:

- Measuring intensification by floorspace and yard space quantum (Rule B) tends to encourage stacking and the conversion of yard space to floorspace, but the total quantum of space to re-provide that the rules sets in place is considered too onerous.
- Measures A and C may encourage more efficient use of yard space but rule B may not always result in more efficient use of yard space. Delivering greater floor space should not compromise yard operation.
- **Operational yard space** (Rule B) should not be included in the floorspace capacity quantum because this rule would not necessarily result in more efficient use of yard space and the amount of yard space needed may vary between developments depending on servicing and operational requirements (eg studio space accessed by light goods vehicles versus cross-docking logistics accessed by HGVs). However operational yard space needs to be carefully considered in development and redevelopment in order to deliver attractive and operational industrial development. Potential for **yard-based** businesses to lose significant proportion of workspace if this is not done well.
- Floorspace capacity target should be defined as applicable to floorspace quantum on site **pre-demolition** (i.e. demolition is not a way 'around' the floorspace capacity measure)
- Measuring intensification by floorspace alone (Rule A) allows for change of use classes without monitoring, **potentially encourages shift to B1c** over B2/B8 due to lesser spatial demands such as lower floor loading and shorter clear span requirements and higher compatibility with residential uses. Market demand and management requirements may balance this.
- **Use-class based** floorspace measurement (Rule C) encourages retention of existing use class mix on a site but is too inflexible in the longer-term.
- Vacant sites and those that currently have a plot ratio less than 65% may not see any intensification greater than a single storey warehouse that meets the 65% plot ratio requirement.

	A. Proposed GFA \geq Existing GFA	B. Proposed GFA + yard space \geq existing GFA + yard space	C. Proposed GFA by use classes \geq existing GFA by use classes
1. Industrial estate			
2. Standalone warehouse			
3. Yard-based			
4. Business centre			
5. Dense industrial			
6. Vacant site			

Key

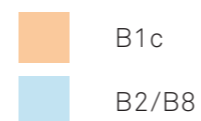

2.3 Measures of intensification

A consideration of the different possible measures of intensification has been carried out in order to determine the best method to monitor and evaluate industrial intensification. Different possible measures considered include:

1. Spatial
2. Economic
3. Process
4. Urban

1. Spatial Intensification

- Aims to increase intensity of land use through delivering additional industrial floorspace on an existing site.
- Might deliver additional space for activities of an existing use class (e.g. B2/B8) or might introduce a new use class (e.g. B1c) onto a given site.
- Requires the co-operation of land owners and needs to take into careful consideration the operational needs and prospects of existing and potential future businesses on site in order to ensure that spatial strategies do not prohibit industrial activities from operating successfully from the new intensified site.
- Includes consideration of access and servicing needs, goods lifts, yard space activities, working hours and environmental impacts.

Measure 1.1: Floorspace

- Pro: Ensures direct re-provision of existing levels of floorspace for industrial activities on a given plot or across a wider area (eg. a SIL/LSIS, borough, London) if considered in net terms.
- Con: Does not capture yard space needs explicitly

Should be considered in line with yard space requirements associated with potential occupiers of a given industrial typology

Measure 1.2: Operational yard space

- Pro: Ensures industrial operations continue to function successfully
- Con: Intensification conditions could prevent inefficient sites being intensified

Should be considered in line with occupier requirements or use class/unit size guidance

Measure 1.3: Additional business units

- Pro: Encourages delivery of smaller units valued by range of occupiers and particularly for SMEs
- Con: Intensification conditions could skew provision away from larger units needed by larger industrial and logistics occupiers

Measure 1.4: Average unit size

- Pro: Unit sizes helpful proxy for providing for different types of occupiers
- Con: Challenge to determine what the ideal mix of unit sizes is and this mix will vary according to the location and predominant function of an industrial area.

Use of size guidance / standards for different (industrial) use classes could be used to inform mix of unit sizes across newly delivered industrial spaces.

Measure 1.5: Mezzanine space

- Pro: Useful measure for ancillary office and other ancillary space for businesses and occupier-specific storage and operational needs eg. WC and bike storage
- Con: Limited use for operations unless properly reinforced (floor loading) and served by goods lift
- Con: Mezzanines are usually occupier-driven so not an appropriate measure of intensification of industrial space
- Con: Can be delivered without planning permission, hard to track. Should be considered (from an occupier perspective) but not considered to be additional floorspace for the purposes of intensification

Should be considered useful (from an occupier perspective) but not considered to be additional floorspace for the purposes of intensification

Measure 1.6: Flexibility of space

- Pro: Ensures possibility of wide range of occupiers / industrial uses
- Con: Difficult to measure and monitor

Use of minimum fit out guidance / standards for different (industrial) use classes could be used to inform flexibility of newly delivered industrial space

2. Economic Intensification

- Aims to attract higher value added uses to an employment area.
- This can be done through changing the type of workspace accommodation available in an area or through targeted business development and incentive schemes to grow existing sector strengths or bring new opportunity sectors into an area.
- Wider considerations of the overall trajectory of the London and UK economy, the impact of other regeneration / development activity across London and changes in technology and working practices should all be considered

Measure 2.1: Jobs

- Pro: Focus on economic opportunities for Londoners
- Con: Industrial activities typically have lower employment densities than other sectors, so this measure might undermine argument for industrial intensification for 'truly' industrial uses and industrial functions (which is concerned more with the 'function' of the industrial activities).

Useful if considered at Borough or London-wide scale as part of wider economic monitoring, but not a suitable measure of industrial intensification.

Measure 2.2: Businesses

- Pro: Focus on business upstarts and clustering businesses in a given area
- Con: Privileges businesses with smaller / less specialised spatial needs (non-industrial)

Useful if considered at Borough or London-wide scale as part of wider economic monitoring

3. Process Intensification

- Involves improvements to technologies used, or through sharing facilities, in order to deliver process efficiencies and make individual businesses and premises more productive.
- Process improvements work to enhance the productivity and value of existing sectors through supporting innovation and technology adoption.

Measure 3.1: Efficiency / throughput / revenue

- Pro: Focus on strategic possibilities like 24-hour operations & new technologies
- Pro: Functional efficiency / throughput could be useful measures for industrial and related functions that do not occupy floorspace, for example bespoke activities such as concrete batching and some utilities and land for transport functions
- Con: Process improvements only available to some businesses, focuses on existing occupiers rather than potential future occupiers / activities

Whilst process intensification can play an important role in ensuring that London's industrial land is maximised, it can not be appropriately measured for most industrial functions for planning purposes and relates closely to individual business fit out and operations. It should therefore not be used to measure industrial intensification for all industrial activities. However, it may be a useful measure in certain circumstances for example bespoke industrial functions that do not occupy industrial floorspace such as concrete batching facilities, utilities and some transport functions.

4. Urban Intensification

- Seeks to deliver improvements which contribute to the quality of the urban realm, can include improvements to transport infrastructure, to public spaces, to amenity spaces or to way-finding.
- Place-making which delivers a high quality environment helps to attract both employers and employees - encouraging existing uses to remain and grow in an area, as well as attracting new businesses into an area.
- Tackling connectivity, congestion and accessibility issues can enable businesses to work more efficiently, employees to access employment opportunities more easily and for particular employment sites to develop.

Measure 4.1: Transport / public realm improvements

- Pro: Focus on improvements to wider area which can be shared by current and future businesses
- Con: Limited application on single site

Measures of urban intensification in industrial areas may be required in order to deliver intensified industrial uses, but are not an appropriate measure of industrial intensification in their own right.

2.3 Measures of intensification

Building on the considerations of different potential measures above, a further consideration of different measures against methods of delivery and scales of intensification has been carried out.

In this table alongside, different methods of intensification (as identified in Policy E7 of the draft London Plan) have been considered across each of the measures listed above. This highlights how different methods do or do not deliver against different potential measures. For example, developing mezzanine levels in an existing industrial building delivers additional floorspace for the existing occupier, but being occupier-driven, does not necessarily deliver usable industrial floorspace for future occupiers. It also does not deliver additional operational yard space, and cannot be guaranteed to deliver additional business units. Each potential measure has also been considered in relation to scales of measurement, in order to better understand the potential to measure intensification. This grades each proposed measure of intensification in terms of ease of calculation across three scales: plot, borough / masterplan area, and London-wide.

Key findings:

- Spatial measures prove to be most effective to measure and evaluate industrial intensification, and of these, floorspace is the best indicator.
- Floorspace should be used as the leading indicator of industrial intensification, with other spatial features as supporting guidance (particularly yard space considerations).
- Economic & urban measures useful at the Borough and London-wide scale as part of wider economic monitoring and regeneration efforts.
- Functional efficiency / throughput measures may be useful in certain circumstances for example bespoke industrial functions that do not occupy floorspace, utilities and some transport functions.

		Method of intensification					Scale of intensification		
		Development of mezzanines	Introduction of smaller units	Development of multi-storey schemes	Addition of basements	More efficient use of land through higher plot ratios	Plot scale	Borough / masterplan area scale	London-wide scale
Measure of intensification	1.1 Floorspace	Possibly delivers	Possibly delivers	Delivers	Delivers	Delivers	Useful measure	Useful measure	Useful measure
	1.2 Operational yard space	Does not deliver	Does not deliver	Possibly delivers	Does not deliver	Does not deliver	Useful measure	Difficult measure	Difficult measure
	1.3 Business units	Possibly delivers	Delivers	Delivers	Possibly delivers	Possibly delivers	Useful measure	Useful measure	Difficult measure
	1.4 Average unit size	Does not deliver	Possibly delivers	Possibly delivers	Possibly delivers	Possibly delivers	Difficult measure	Useful measure	Difficult measure
	1.5 Mezzanine space	Delivers	Possibly delivers	Possibly delivers	Does not deliver	Does not deliver	Difficult measure	Difficult measure	Difficult measure
	Flexibility of space	Possibly delivers	Possibly delivers	Delivers	Possibly delivers	Possibly delivers	Useful measure	Difficult measure	Difficult measure
	2.1 Jobs	Possibly delivers	Possibly delivers	Possibly delivers	Possibly delivers	Possibly delivers	Difficult measure	Useful measure	Useful measure
	2.2 Businesses	Possibly delivers	Delivers	Possibly delivers	Possibly delivers	Possibly delivers	Difficult measure	Useful measure	Useful measure
	3.1 Efficiency / revenue	Possibly delivers	Possibly delivers	Possibly delivers	Possibly delivers	Possibly delivers	Useful measure	Difficult measure	Difficult measure
	4.1 Urban improvements	Does not deliver	Does not deliver	Possibly delivers	Does not deliver	Does not deliver	Difficult measure	Useful measure	Difficult measure

Key

- Delivers
- Possibly delivers
- Does not deliver
- Useful measure
- Difficult measure

2.4 Conclusion

What is industrial intensification?

Industrial intensification refers to development on designated SIL or LSIS where the new development provides industrial floorspace that is greater than or equal to the existing industrial floorspace capacity.

Industrial intensification may occur in two ways:

1. Intensification of industrial and related uses only on designated sites, and
2. Intensification & co-location of industrial uses with residential/non-industrial uses on non-designated sites or on designated sites where this meets the policy criteria in the new London Plan.

Measuring intensification

The accepted measure of intensification is industrial¹ floorspace in the existing and proposed conditions (sqm). New London Plan policy also considers the potential industrial floorspace capacity that could be accommodated on a site at a 65% plot ratio [defined as total industrial floorspace (sqm) divided by total site area (sqm)]

Other measures of intensified use of industrial sites, such as increased number of jobs, number of businesses, increased hours of operation, functional efficiency and throughput etc may be used to understand the impacts of intensification.

Interpreting 'no net loss'

The requirement for no net loss of industrial floorspace capacity within designated SIL or LSIS may be considered at a site-specific level, or across a planned area. No net loss on designated industrial sites will need to be achieved by a plan-led and/or masterplan-led process taking into account the impact of any development on the wider designated industrial site, as opposed to ad-hoc development of individual sites.

Understanding local economies

Industrial intensification processes can encourage the provision of certain spatial typologies over others. In order to ensure that industrial intensification appropriately supports the diversity of local economies, an area-wide understanding of supply and demand is required.

Yard space & parking

Capacity and requirements for operational yard space must be considered on a case-by-case basis having regard to existing and potential occupiers and informed by the current supply and future demand profile for industrial activity. Requirements for parking are set out in the new London Plan policies:

- Policy T5 Cycling (and minimum cycle parking standards)
- Policy T6 Car parking
- Policy T6.2 Part C (car parking standards for B2 and B8) and Table 10.4
- Policy T6.5 Non-residential disabled persons parking
- For co-location schemes with non-industrial and/or residential co-location – other relevant parking policies will apply (eg T6.1 – T6.4).

Ensuring spatial suitability

Use of design guidance for different industrial use classes could be used to inform newly delivered industrial spaces.

1 * Planning Use Classes B2, B8 and B1c

3.0 INDUSTRIAL UNIT SPECIFICATION

3.1 Occupier/ typology categorisation

In order to develop design propositions, a categorisation of industrial space typologies has been developed. This typology structure also supports the design specification development and scheme costing that follows.

The typologies are determined primarily by building footprint size (in accordance with standard property market categories). Furthermore, each typology can be further categorised by yard, parking and specification needs which are reflective of the needs of different groups of industrial occupiers. By developing a size-led typology rather than occupier-led typology, the categories of space are generic enough to suit 'on spec' development, rather than being overly determined by a particular occupier.

This typology structure differentiates between occupiers that make use of yard space for their primary activity, distinct from the overall loading / delivery needs that are pertinent to all industrial operators. These yard-based businesses conduct some or all of their primary activities in outdoor / yard space. For example, construction wholesale businesses need yard space for the storage of materials like timber / scaffolding, recycling operations need yard space for piling of materials / to deal with the fumes / dust, and plant hire businesses use yard spaces to park / store their equipment for hire. The implication is that these occupiers need some dedicated yard space, rather than shared yard (which is an option for most other occupiers).

Industrial Typology	Built Footprint	Typical Use Class	Yard for Primary Operations (i.e. yard-based business)	Customer Parking	Specialist Specification	Typical Occupiers
Workshop/ Studio Space	10-500m ² (100-5,000 ft ²) Terraced provision possible/ likely	B1C	No	No		Manufacturing (textile), arts & creative, other maker activities
Small Industrial Units	< 1,000 m ² (<10,000 ft ²) Terraced provision possible/ likely	B1C/ B2/ B8	Yes	Yes		Construction-related trade counters or wholesale
				No		Specialist recycling
			No	Yes		Urban services, trade counter
				No	Extraction/ refrigeration	Manufacturing (metal), food/ catering, flexible SME
Medium Industrial Units	1,000 to 5,000 m ² (10,000 - 50,000 ft ²) Terraced provision possible	B2/ B8	Yes	Yes		Construction-related trade counters, wholesale & hire
				No		Specialist recycling
			No	Extraction/ refrigeration	Food production/ catering, Manufacturing (other, general), Manufacturing (metal),	
Large Industrial Units	+5,000m ² (50,000 ft ² - +100,000ft ²) Standalone provision likely	B2/ B8	Yes	Yes		Construction-related trade counters, wholesale & hire
				No		Construction, transport, logistics
			No	Yes		Wholesale suppliers, wholesale markets
				No	Extraction/ refrigeration	Manufacturing (other, general), printing & publishing, food (large scale)
Industrial Yard	None/ Negligible	B2/ B8	Yes	No		Vehicle hire & repair, construction, transport, aggregates
Bespoke	Varies	B2/ B8 Sui generis	Varies	No		Utilities & waste, transport functions, emerging activities (data centres etc)

3.2 Requirements for industrial space

Workshops / studios specification



Stacked industrial - Timber frame
Yardhouse, Assemble



Stacked Industrial - Steel frame
Great Western Studios

	General design requirements	Additional stacked industrial requirements	Additional mixed industrial-residential requirements
Dimensions	<p>Area</p> <ul style="list-style-type: none"> — Area per small unit = 10-32m² — Typical floor plate dimensions = 3 x 7m — Area per large unit = 32-500m² — Typical floor plate dimensions = 12 x 25m <p>Height</p> <ul style="list-style-type: none"> — Ceiling height = minimum 3.5 - 4.4m 		<p>Area comparison</p> <ul style="list-style-type: none"> — Small units approx half the size of a typical residential floor plate — Large units approx 5 times the size of typical residential floor plate
Access & servicing	<p>Access</p> <ul style="list-style-type: none"> — Locking door for individual units — Minimum opening width of 0.9m <p>Yard space</p> <ul style="list-style-type: none"> — 16m yard depth for LGV access — Shared loading area for occasional HGV access (27m loading depth for one HGV) <p>Services</p> <ul style="list-style-type: none"> — Heating through wet system or space heaters — 3 phase power supply preferred — Water supply 	<p>Upper floors</p> <ul style="list-style-type: none"> — Wide corridors minimum 1800mm to allow for one forklift truck (consider inclusion of passing space for pedestrians) — Goods lift(s) for vertical material movements (minimum 500kg - 1000kg loading) 	<p>Residential access</p> <ul style="list-style-type: none"> — Separate circulation cores for residential access
Environmental considerations	<p>Emissions</p> <ul style="list-style-type: none"> — Localised extract system for noxious outputs 		<p>Noise</p> <ul style="list-style-type: none"> — Above 43 Rw dB - concrete floor of mass greater than 365kg/m²
Exterior & interior	<p>Design</p> <ul style="list-style-type: none"> — Non-structural dividing walls for maximum flexibility — Sliding and lockable division walls to enable sub-division of spaces 		<p>Facade Treatment</p> <ul style="list-style-type: none"> — Compatibility with surrounding residential uses may require higher specification facade treatment

Small industrial specification



Stacked industrial - Concrete frame
Gewerberhof Laim, Munich, Bogevischs Buero



Stacked industrial - Steel frame
KaaP Noord, Amsterdam, VSAP Architects

	General design requirements	Additional stacked industrial requirements	Additional mixed industrial-residential requirements
Dimensions	<p>Area</p> <ul style="list-style-type: none"> — Area per unit = 500-1000m² — Typical floor plate dimensions = 20 x 40m <p>Height</p> <ul style="list-style-type: none"> — Ceiling height = minimum 4 - 8m <p>Mezzanine levels</p> <ul style="list-style-type: none"> — Option if double height space (minimum 6m) — Typically 10% of floor area 		<p>Area comparison</p> <ul style="list-style-type: none"> — Units approx 8 times the size of a typical residential floor plate
Access & servicing	<p>Access</p> <ul style="list-style-type: none"> — Roller-shuttered doors for deliveries — Opening with height of 3.7m and width of 2.4-3m — Separate staff/visitor access <p>Yard space</p> <ul style="list-style-type: none"> — 16m yard depth for LGV access — Shared loading area for occasional HGV access (27m loading depth for one HGV) <p>Services</p> <ul style="list-style-type: none"> — Radiator heating to office areas — Blow air heating to work areas — 3 phase power supply required — Water supply — Drainage from floor areas 	<p>Upper floors</p> <ul style="list-style-type: none"> — Wide corridors minimum 3500mm to allow for two forklifts to pass (consider inclusion of passing space for pedestrians) — Goods lift(s) for vertical material movements (minimum 500kg - 4000kg loading) — Ramped access for direct vehicular access to upper level units (optional) 	<p>Residential access</p> <ul style="list-style-type: none"> — Separate passenger circulation cores for residential access
Environmental considerations	<p>Noise</p> <ul style="list-style-type: none"> — Sound mitigation by careful design to minimise flanking sound transmission <p>Emissions</p> <ul style="list-style-type: none"> — Extract system for noxious outputs 		<p>Noise</p> <ul style="list-style-type: none"> — Above 43 Rw dB - concrete floor of mass greater than 365kg/m²
Exterior & interior	<p>Design</p> <ul style="list-style-type: none"> — Large clear spans for maximum flexibility 		<p>Facade Treatment</p> <ul style="list-style-type: none"> — Compatibility with surrounding residential uses may require higher specification facade treatment

Medium industrial specification



Stacked industrial - Steel frame
Here East, Hawkins\Brown



Mixed industry - residential - Concrete frame
Travis Perkins Kings Cross, Cooley Architects

	General design requirements	Additional stacked industrial requirements	Additional mixed industrial-residential requirements
Dimensions	<p>Area</p> <ul style="list-style-type: none"> — Area per unit = 1,000-5,000m² — Average floor plate dimensions = 40x80m <p>Height</p> <ul style="list-style-type: none"> — Ceiling height = minimum 6 - 8m — For larger footprint buildings the height may increase to minimum 10 - 13m for warehousing operations <p>Mezzanine levels</p> <ul style="list-style-type: none"> — Option as a result of high ceiling heights — Usually 10% of floor area 		<p>Area comparison</p> <ul style="list-style-type: none"> — Units approx 50 times the size of a typical residential floor plate
Access & servicing	<p>Access</p> <ul style="list-style-type: none"> — Loading doors for deliveries — Openings with a height of 4m and width of 2.4-3m — Separate staff/visitor access — Dock levellers expected for units above 2,300sqm <p>Yard space</p> <ul style="list-style-type: none"> — 27m yard depth for HGV access to individual units <p>Services</p> <ul style="list-style-type: none"> — Radiator heating to office areas — Radiant heating panels — 3 phase power supply required — Water supply — Petrol interceptor for drainage — High bay lighting 	<p>Upper floors</p> <ul style="list-style-type: none"> — Wide corridors minimum 3500mm to allow for two forklifts to pass (consider inclusion of passing space for pedestrians) — Goods lift(s) for vertical material movements (minimum 500kg - 4000kg loading) — Ramped access for direct vehicular access to upper level units (optional) 	<p>Residential access</p> <ul style="list-style-type: none"> — Separate passenger circulation cores for residential access
Environmental considerations	<p>Noise</p> <ul style="list-style-type: none"> — Sound mitigation by careful design to minimise flanking sound transmission <p>Emissions</p> <ul style="list-style-type: none"> — Local extract ventilation systems for noxious outputs 		<p>Noise</p> <ul style="list-style-type: none"> — Above 43 Rw dB - concrete floor of mass greater than 365kg/m²
Exterior & interior	<p>Design</p> <ul style="list-style-type: none"> — Large clear spans for maximum flexibility 		<p>Facade Treatment</p> <ul style="list-style-type: none"> — Compatibility with surrounding residential uses may require higher specification facade treatment

Large industrial specification



Single storey - Steel frame
Unit 2, Origin, Park Royal, Segro



Stacked industrial - Steel frame with concrete ramp
X2 Warehouse Hatton Cross, Cornish Architects

	General design requirements	Additional stacked industrial requirements	Additional mixed industrial-residential requirements
Dimensions	<p>Area</p> <ul style="list-style-type: none"> — Area per unit = +5,000m² — Typical floor plate dimensions = 50x100m <p>Height</p> <ul style="list-style-type: none"> — Ceiling height = minimum 10 - 13m <p>Mezzanine levels</p> <ul style="list-style-type: none"> — Usually 10% of floor area 		<p>Area comparison</p> <ul style="list-style-type: none"> — Units approx 75 times the size of a typical residential floor plate
Access & servicing	<p>Access</p> <ul style="list-style-type: none"> — Loading doors for deliveries — Openings with a height of 4m and width of 2.4-3m — Separate staff/visitor access — Dock levellers expected at this scale <p>Yard space</p> <ul style="list-style-type: none"> — 27m yard depth for HGV access to individual units <p>Services</p> <ul style="list-style-type: none"> — Radiator heating to office areas — Radiant heating panels — 3 phase power supply required — Water supply — Petrol interceptor for drainage — High bay lighting 	<p>Upper floors</p> <ul style="list-style-type: none"> — Ramped access for direct vehicular access to upper level units 	<p>Residential access</p> <ul style="list-style-type: none"> — Separate passenger circulation cores for residential access
Environmental considerations	<p>Noise</p> <ul style="list-style-type: none"> — Sound mitigation by careful design to minimise flanking sound transmission <p>Emissions</p> <ul style="list-style-type: none"> — Local extract ventilation systems for noxious outputs 		<p>Noise</p> <ul style="list-style-type: none"> — Above 43 Rw dB - concrete floor of mass greater than 365kg/m²
Exterior & interior	<p>Design</p> <ul style="list-style-type: none"> — Large clear spans for maximum flexibility <p>Facade treatment</p> <ul style="list-style-type: none"> — Typical light elevational treatment (e.g. corrugated metal) 		

Structural grids

To allow maximum operational flexibility, industrial occupiers prefer large clear spans within their buildings. In single storey accommodation this is typically straight-forward to achieve. However, vertical mix of space above ground floor industrial units limits the clear-span distances due to increased structural loading.

Single storey precedents

Large single storey industrial provision typically offers clear spans of +30m. Whilst these spans are achievable with traditional single-storey steel portal frames, they are not likely to be structurally efficient options for stacked industrial provision.

Stacked industrial structural grids

Stacked large industrial precedents in the UK and overseas show examples of clear spans of around 10-15m. Whilst these are significantly less than those achieved with single storey steel portal frames, they provide much more structurally efficient solutions for vertical mix, with limited impact on industrial operations for many occupiers.

Based upon a series of studies testing potential clear spans against structural efficiency with input from structural engineers and cost consultants, an optimum structural grid for vertically-mixed buildings was established at around 15m. This provided an appropriate balance of clear floorspace, compatibility with storage racking, compatibility with dock levellers/ loading bays and cost effective structure. This guidance does not negate the need for scheme-specific structural proposals.

Floor loadings

In the context of multi-level industrial accommodation, consideration of floor loadings is a key factor affecting both suitability of space for occupiers and build cost.

Typical industry values

Industrial providers and agents currently specify high floor loadings (25-50kN/m²) as a standard specification. These are often easily achievable with single-storey, ground-bearing provision, maximising flexibility to allow for the widest range of potential occupiers. With a move towards industrial intensification and multi-level schemes however, such high values may not actually be required by occupier activities. Therefore in these situations such typical values should be queried and justified in order to balance occupier flexibility with structural design and cost efficiency.

British Standards

The British Standards for floor loadings for industrial uses are significantly lower than the industry standards (2.5-15kN/m²). Storage uses require higher floor loadings (minimum 15kN/m²) and are related to the stacking height available (4.8kN/m² per metre of storage height). This suggests that 'industry standard' floor loading specifications can be appropriately challenged.

For example, the typical height of medium industrial provision is 7m. The minimum floor loading requirements to allow for storage and warehousing use can therefore be calculated to be 4.8x7= 33.6kN/m². This is considerably lower than the maximum floor loading industry standards of 50kN/m².

Future stacked industrial provision

Studies show that achieving current industry standards for floor loadings is unlikely to be cost effective for multi-level provision, and may not be practically achievable. British Standards support a more modest approach to floor loadings in order to maximise structural efficiency and therefore overall build costs.

A sensible approach would be to design to provide higher floor loadings on the ground floor and lower floor loadings on the upper floors to maximise structural efficiency and provide space for a range of occupiers. Whilst this may narrow the market of occupiers for upper floor provision, it has the potential to considerably improve viability of schemes.

Typical industry values

	Use Class	Floor Loading	Additional info
Workshops and studios	B1c	15-25kN/m ²	
Small industrial	B1c/B2/B8	15-25kN/m ²	
Medium industrial	B2/B8	25kN/m ²	6m clear internal height
		35kN/m ²	8m clear internal height
Large industrial	B2/B8	35kN/m ²	8m clear internal height
		50kN/m ²	+8m clear internal height

British Standards

	Use Class	Floor Loading
Light industrial Workrooms without storage	B1c	2.5kN/m ²
General industrial Factories, workshops and similar buildings	B2	5.0kN/m ²
Storage Dense mobile stacking (books) on mobile trucks in warehouses	B8	4.8kN/m ² per metre of storage height with a minimum 15kN/m ²
Light traffic Parking for cars and light vans not exceeding 2500kg	N/A	2.5kN/m ²
Heavy traffic Loading for HGVs	N/A	15kN/m ² with an additional requirement for 160kN axle load for fire engines

3.3 Additional design considerations

Acoustic and other environmental mitigation

A number of measures would need to be considered to ensure acoustic and other environmental mitigation (such as odours, dust and vibration) between the industrial and residential uses. These typically include the wall and floor construction between adjacent and stacked uses as well as measures to reduce noise, dust and smell from industrial uses including:

- Increased wall and floor acoustic performance specification
- Non-opening windows and mechanical ventilation
- Triple glazing
- Winter gardens
- Acoustic fences
- Enclosing canopies or roof structures above industrial activity and yard space
- Appropriate extraction and ventilation provided for industrial uses
- Considering position of ‘blow out’ safety vents on safety equipment

Acoustic and other environmental nuisance complaints can not be controlled solely via the planning and building control systems. Complaints may be enforced via the Environmental Protection Act 1990¹ and as such careful consideration of design proposals is required, and curation or restriction of industrial activity may be required in co-location schemes.

¹ <https://www.gov.uk/guidance/noise--2>

Car parking

Draft London Plan (2017) Policy T6.2 sets out a clear direction supporting public transport and active travel and states office parking provision should be kept to a minimum. In the Plan, Use Class Order B2/B8 should have regard to these office standards but ‘take account of the significantly lower employment density in such developments, and consider a degree of flexibility to reflect different trip-generating characteristics’.

Maximum office parking standards

Location	Maximum parking provision
Central Activities Zone and inner London	Car-free
Outer London Opportunity Areas	Up to 1 space per 600 sqm gross internal area (GIA)
Outer London	Up to 1 space per 100 sqm (GIA)
Outer London locations identified through a Development Plan Document where more generous standards apply	Up to 1 space per 50 sqm (GIA)

Disabled car parking

Disabled persons car parking is set out in the London Plan in Policy T6.5 Non-residential disabled persons parking. The policy states ‘All non-residential elements of a development should provide at least one on or off-street disabled persons parking bay.’ The Non-residential disabled person parking standards applicable to workspace provision are shown in the below table.

Non-residential disabled persons parking standards

	Designated bays (Per cent of total parking provision)	Enlarged bays (Per cent of total parking provision)
Workplace	5 per cent	5 per cent

Cycle parking

Draft London Plan (2017) Policy T5 states that developments should provide cycle parking in accordance with the minimum standards set out in Table 10.2 and Figure 10.2. Cycle parking should also be designed and laid out in accordance with the guidance contained in the London Cycling Design Standards. Table 10.2 outlines the minimum cycle parking standards.

Maximum cycle parking standards

Use Class		Long-stay (e.g. for residents or employees)	Short-stay (e.g. for visitors or customers)
B1	Light industry and research and development	1 space per 250 sqm (GEA)	1 space per 1,000 sqm (GEA)
B2-B8	General industrial, storage or distribution	1 space per 500 sqm (GEA)	1 space per 1,000 sqm (GEA)

Urban greening

Draft London Plan (2017) Policy G5 outlines the Urban Greening requirements of new development. Urban greening measures include high quality landscaping (including trees), green roofs, green walls, rain gardens and nature based sustainable drainage. The plan states “Boroughs should develop an Urban Greening Factor (UGF) to identify the appropriate amount of urban greening required in new developments. The UGF should be based on the factors set out in Table 8.2, but tailored to local circumstances. In the interim, the Mayor recommends a target score of 0.4 for developments that are predominately residential, and a target score of 0.3 for predominately commercial development.”

This study has not explored Urban Greening Factor on industrial intensification schemes in great detail, although in marginally viable scheme the associated uplift in build cost could prove problematic. Opportunities for urban greening have been highlighted in each model site scheme, and all could achieve the required level of 0.3, should build costs allow.

4.0

URBAN SCALE GUIDANCE

The following urban scale guidance is for the development of industrial intensification and associated co-location with residential. The guidance covers site layout and frontage, movement, access, yards, servicing, amenity space and adjacent uses.

4.1 Site layout and frontage

1.1 Deliver an efficient site layout

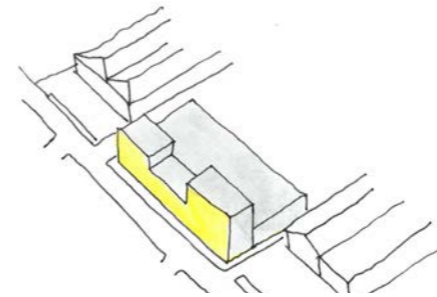

Build to the edge of the plot on street frontage to create a cohesive street character and remove the need for fences.

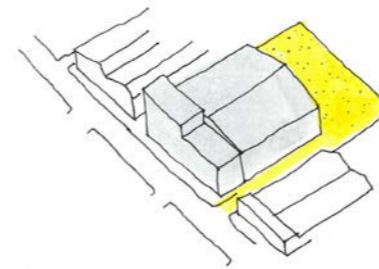

Locate yard and loading space away from the street edge towards the middle or rear of the site.

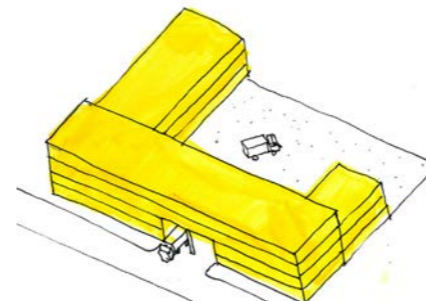

Encourage stacking to increase industrial space provision on the site.

1.2. Provide positive street frontage

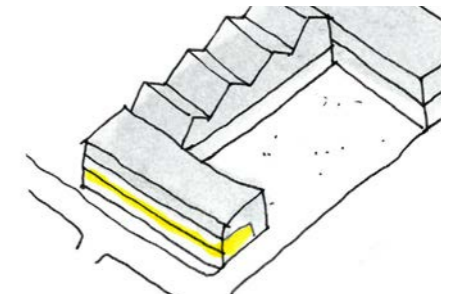

Position most active uses or operational making areas at ground floor along the street.



Ensure that ground floor uses adjacent to the street have high levels of visual permeability.

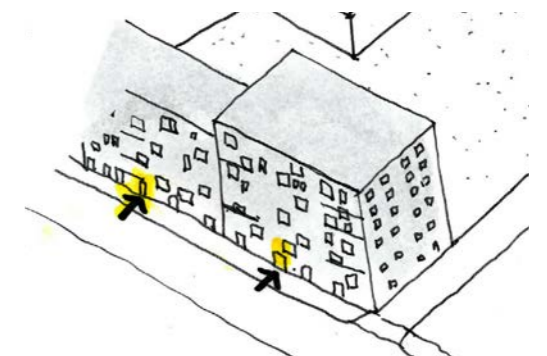

Locate residential entrances and units along the street edge to provide positive street frontage.

4.2 Movement

2.1 Create a hierarchy of movement and manage HGV access

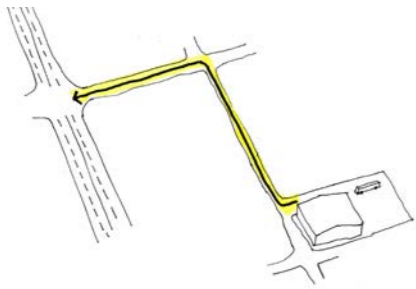

Ensure HGV routes connect to the strategic network as efficiently as possible to reduce conflict between HGVs and other road users.

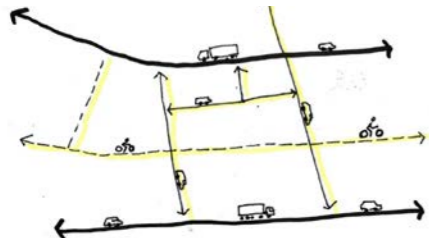

Separate modes of transport where necessary and consider limiting the types of vehicles that can use particular routes.

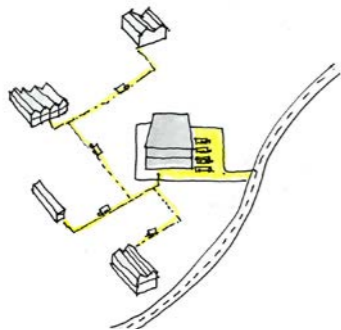

Promote businesses working together to consolidate deliveries where possible to reduce HGV movements.

2.2 Promote active transport



Design junctions that are safe and easy to cross for pedestrians and cyclists.

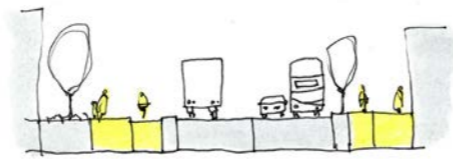

Deliver legible cycle and pedestrian routes to public transport links such as railway stations.

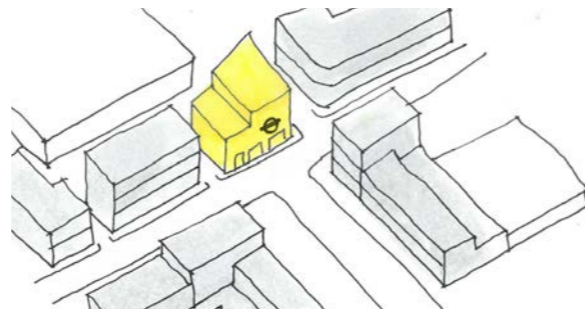

Locate higher employment densities such as B1c and studio space in areas with higher PTAL.

4.3 Access, yards, servicing & parking

3.1 Separate access for different uses

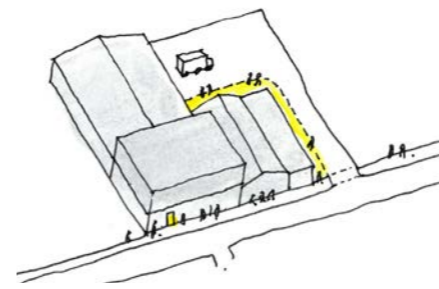

Provide a dedicated pedestrian entrance directly from the street and segregate servicing and pedestrian routes

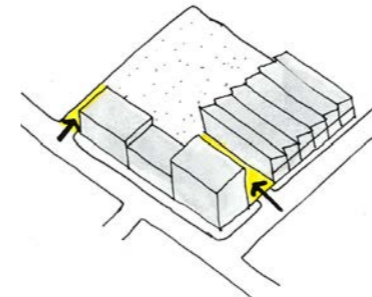

Take advantage of sites with access from multiple sides to separate access.

3.2 Optimise yard space

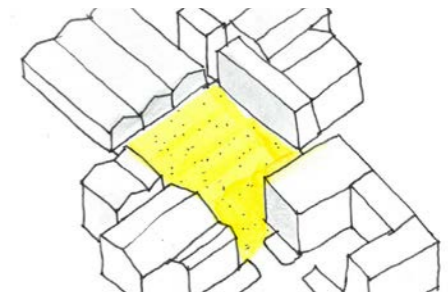

Consider shared yard to optimise space on smaller sites.

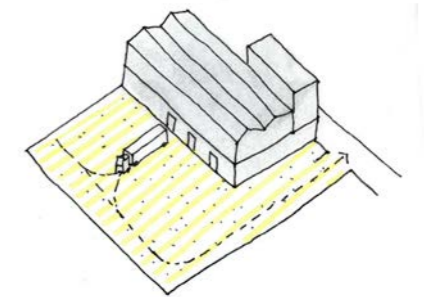

Incorporate sufficient space for HGV turning circles within the site to prevent HGV manoeuvring on highways.

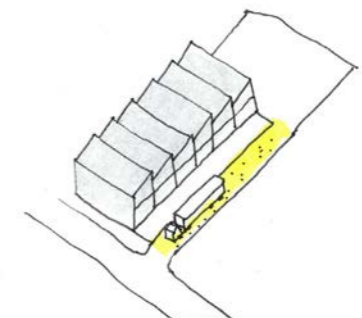

Consider provision of shared HGV parking for units that only require occasional HGV access.

4.4 Amenity space

4.5 Adjacencies

3.3 Manage parking

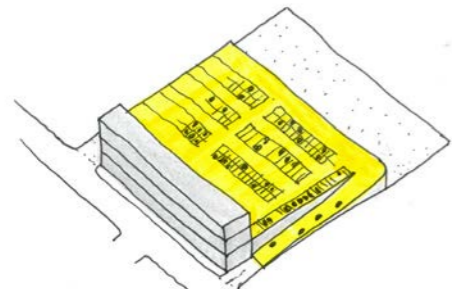

Where required, provide parking on the roof of buildings to meet parking requirements and not reduce yard or industrial space.

4.1 Create better places

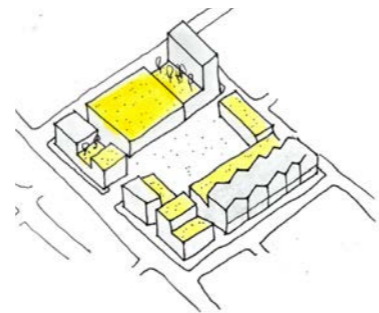

Use green roofs to provide amenity space for workers and residents and contribute to urban greening.

5.1 Avoid residential overlooking and minimise noise issues

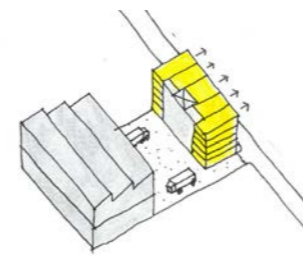

Orient industrial and residential units to minimise overlooking of yard space.

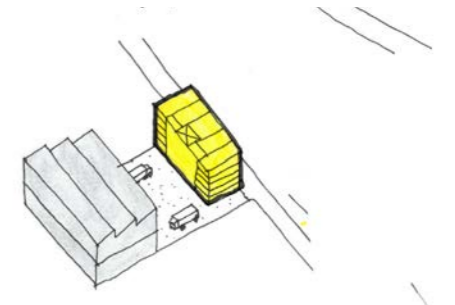

Incorporate acoustic mitigation measures such as winter gardens, non opening windows and mechanical ventilation, triple glazing and wall and floor build-ups into residential blocks.

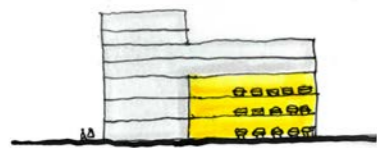

Integrate parking within buildings and away from the street edge and separate yard-space, employee parking and visitor parking

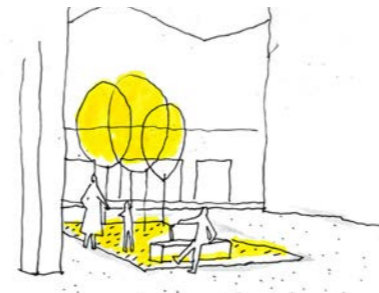

Create well designed public spaces and meeting places, avoid creating new low quality green space at the edge of an industrial site, or 'industrial scrub'.

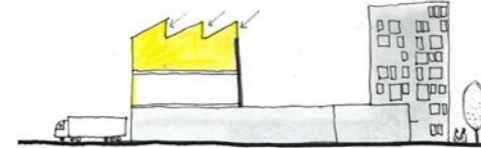

Use top lighting for industrial space to reduce the need for windows overlooking residential units.

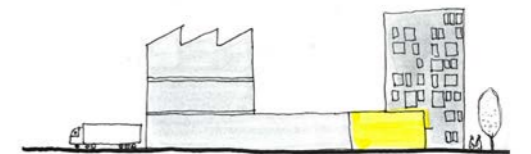

Use ancillary uses to provide a buffer between residential and industrial uses such as parking or cycle storage.

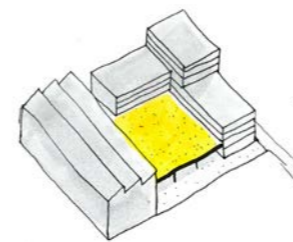

Consider a decking structure over the yard to mitigate against visual and noise issues associated with industrial servicing and provide residential amenity space.

5.0

MODEL SITES

5.1 Site selection and method

In order to explore the viability of industrial intensification across London, three different sites have been selected for testing. These sites are representative of different industrial and urban conditions across London, namely:

1. **Inner London** designated industrial land sites (SIL or LSIS), located in boroughs with high average residential values;
2. Strategic Industrial Land (SIL) sites in **suburban area**, located in boroughs with low residential values;
3. Locally significant industrial sites (LSIS) in **urban areas**, located in Boroughs with medium residential values.

One location from each of these categories has been selected for design work and viability testing, with the implication that the resultant findings are broadly applicable to a wider range of sites across London in similar conditions (designation, geography and residential values). Furthermore, the particular sites chosen in each location for detailed test are also representative of common site sizes in that given location.

Area 1 common site size bracket: 0.3 - 1 ha
 Area 2 common site size bracket: 1.25 - 6 ha
 Area 3 common site size bracket: 0.4 - 1.05 ha

This selection process has been undertaken in order to develop schemes based in economic and spatial realities, while also generating findings that are applicable across London's varied industrial land sites.

Residential value bands, based on new-build sales values per square meter (at July 2017)¹:

Band A: £19,597 to £41,438
 Band B: £10,073 to £19,597
 Band C: £7,834 to £ 10,073
 Band D: £5,609 to £ 7,834
 Band E: £2,384 to £5,609

¹Residential values are taken from the London Plan Viability Study, to draw together a borough-wide residential value average. For full methodology and caveats to these values, please refer to the London Plan Viability Study (2017), Annex B.

1. Inner, SIL/LSIS, high residential values

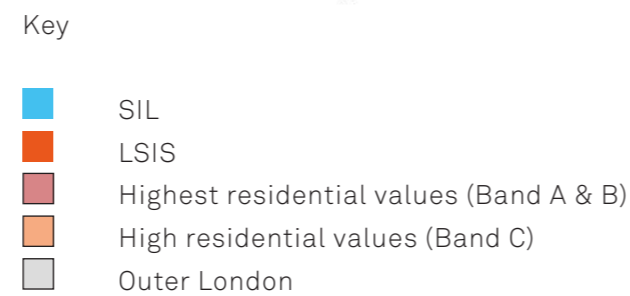
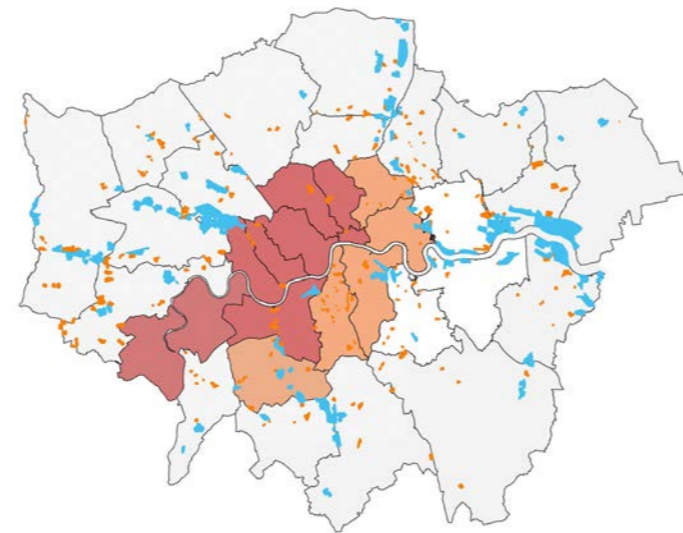

2. Suburban, SIL, low residential values

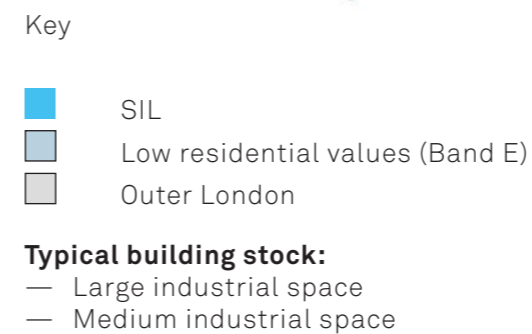

3. Urban, LSIS, medium residential values

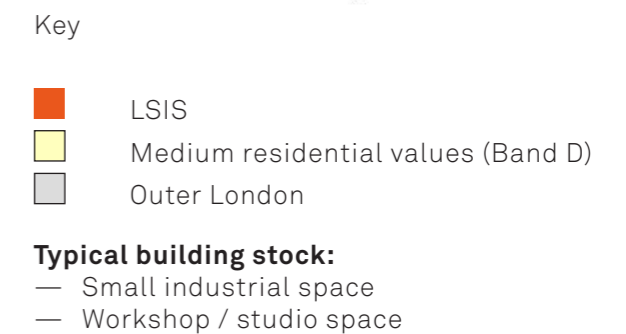
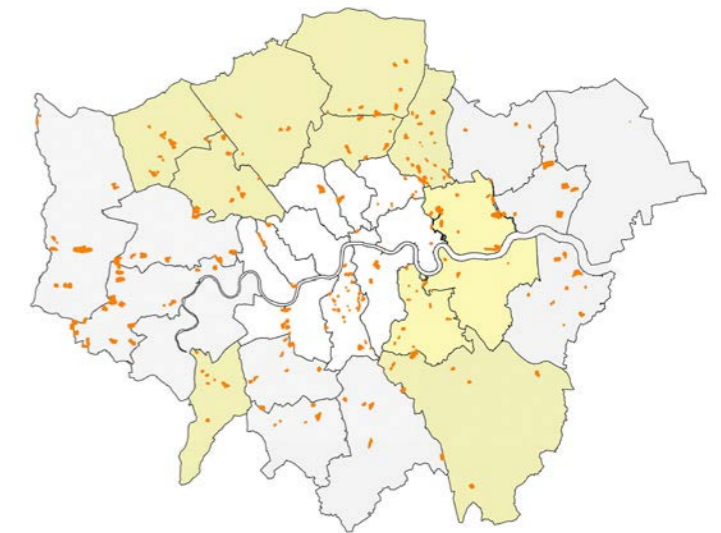





5.2 Approach to model sites

Across the three selected model sites, four schemes have been designed and tested for viability. These schemes are highlighted in colour in the table opposite. Build costs and viability results have then been extrapolated to provide general guidance for varying typologies, shown in this table in grey. Further details are described in section 6 of this report.

	Area 1: Inner London	Area 2: Suburban London	Area 3: Urban London
A. Stacked large industrial	 Scheme appraisal with generic build costs	 Design tested and detailed appraisal	 Scheme appraisal with generic build costs
B. Stacked medium industrial with residential	 Design tested and detailed appraisal	 Scheme appraisal with generic build costs	 Scheme appraisal with generic build costs
C. Stacked workshop / studio with residential	 Design tested and detailed appraisal	 Scheme appraisal with generic build costs	 Scheme appraisal with generic build costs
D. Stacked small industrial with residential	 Scheme appraisal with generic build costs	 Scheme appraisal with generic build costs	 Design tested and detailed appraisal

Key

	Workshops/studios space
	Small industrial space
	Medium industrial
	Large industrial space
	Residential

Area 1
Inner London

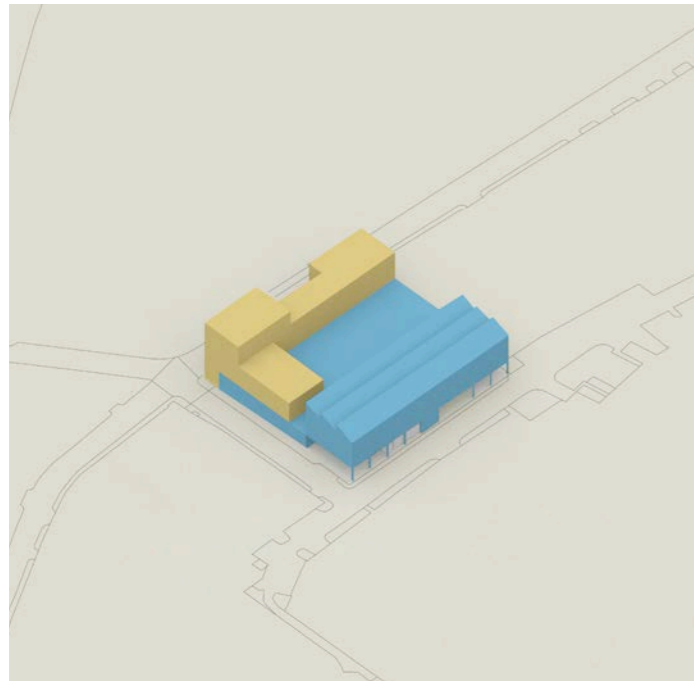

Model Site 1A
Stacked medium industrial with residential above

This scheme provides a single medium industrial unit at ground floor, with smaller upper level units in order to comply with the 'no net loss of existing floorspace' requirement. Residential accommodation is incorporated fronting onto an adjacent residential street. An industrial yard and loading space is located along an access road within an industrial estate to the rear.

Area 2
Suburban London

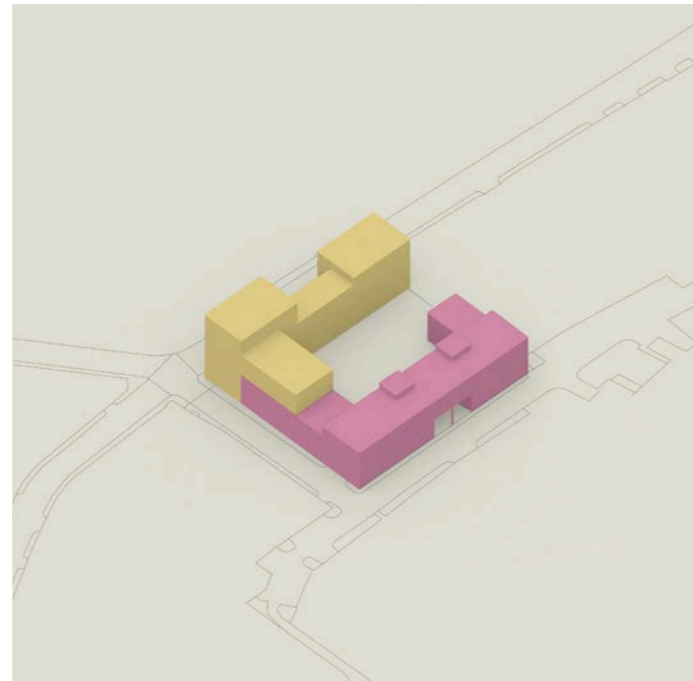

Model Site 1B
Stacked workshops / studios with residential above

This scheme provides multi-level workshop/studio space, combined with residential accommodation fronting onto an adjacent residential street. An internal working yard sits between the two uses.

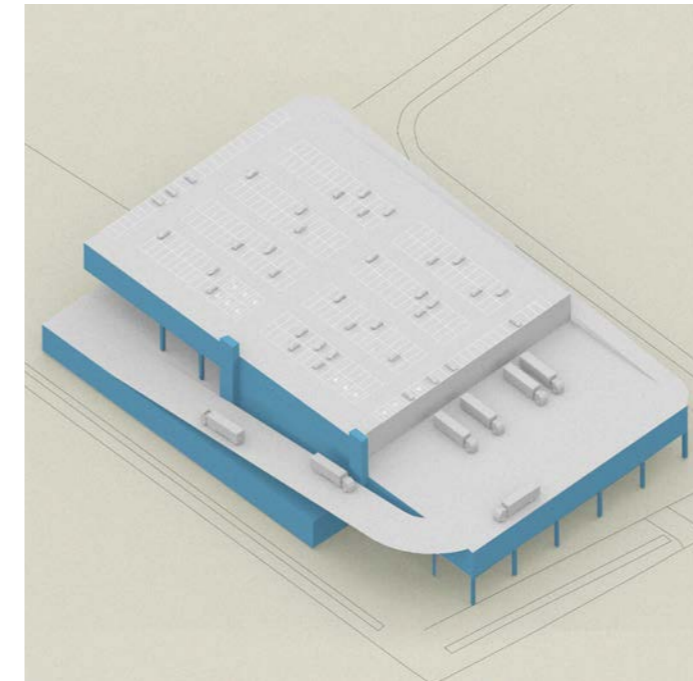

Model Site 2
Stacked large industrial

This scheme proposes a multi-level industrial building at large scale. HGV access to all three levels is possible and car parking is provided at roof level to maximise the amount of floorspace achieved on the site.

Area 3
Urban London

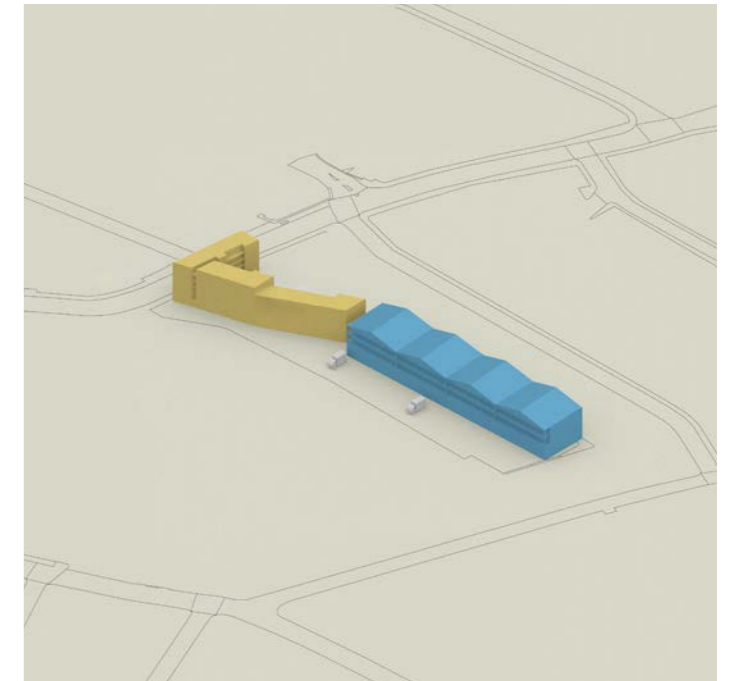

Model Site 3
Stacked small industrial with adjacent residential

This scheme proposes stacked small industrial units at the rear of the site, which allows residential accommodation to be delivered on the areas 'released' from ground level industrial provision.

KEY

- Industrial units
- Workshops and studios
- Residential units

5.3

Area 1: Inner London

Existing conditions

Plot size	5,162 m ²
Industrial space	4,892 m ² GFA
No. of storeys	1-3 storeys
Yard space	1,359 m ²
Parking	10 spaces
Plot ratio	95%

Industrial land designation

- Strategic Industrial Location

Other land designations

- Inner London Opportunity Area

Existing uses

- B2 (General industrial)

Access

- Potential access from 3 sides



Context

- On northern boundary of SIL
- Predominantly surrounded by industrial use
- Residential use to the north

Transport connections

- PTAL 2
- Well connected to the strategic road network

KEY

-  Industrial space
-  Yard

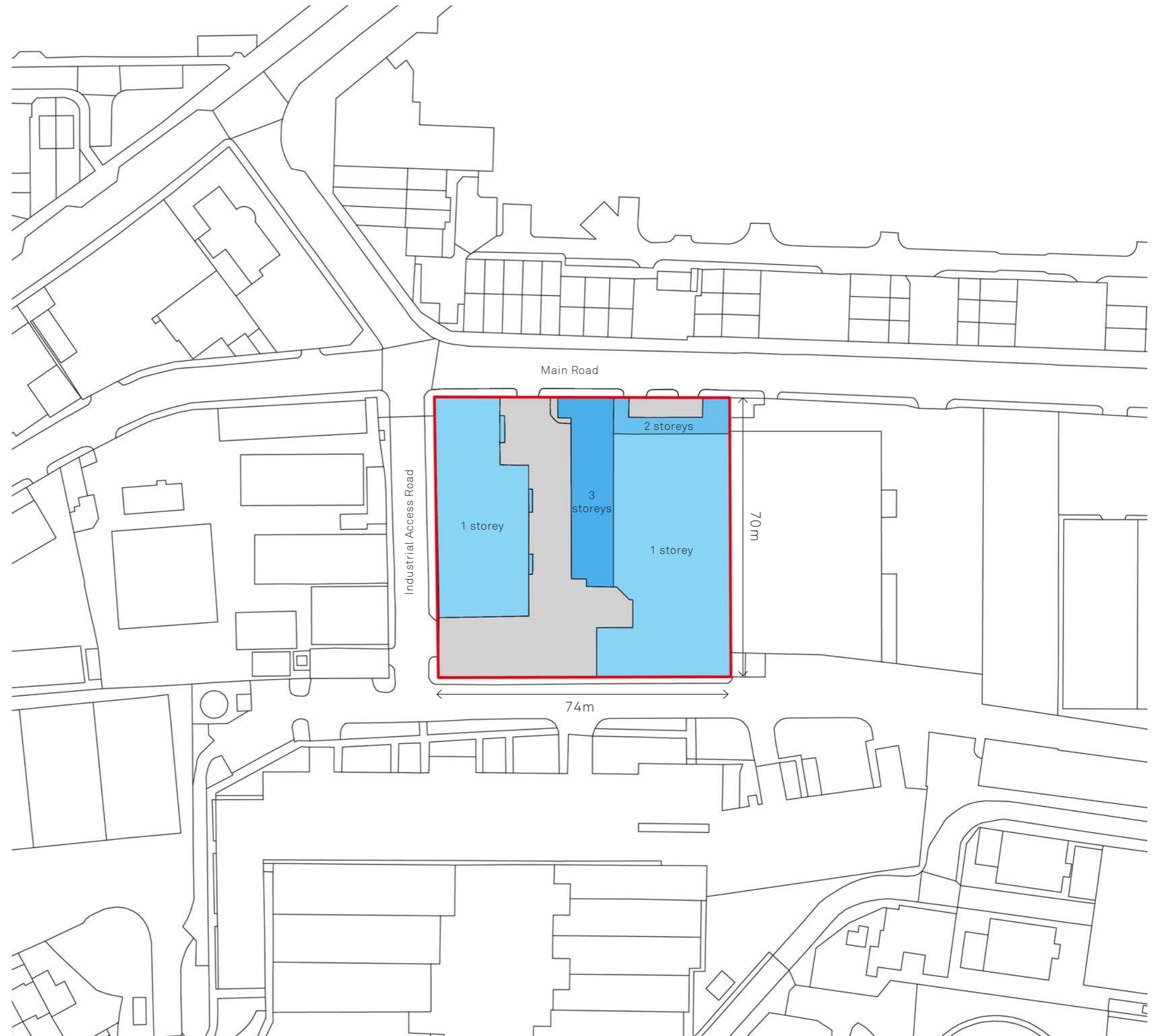
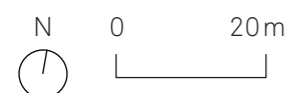

Ground Floor Plan

5.4

Model site 1

Stacked medium industrial with residential above

Development options

A series of development proposals testing medium industrial provision combined with new residential development. The models test the quantity of industrial and residential provision, location of yard space and goods lift access as well as the potential for urban greening.

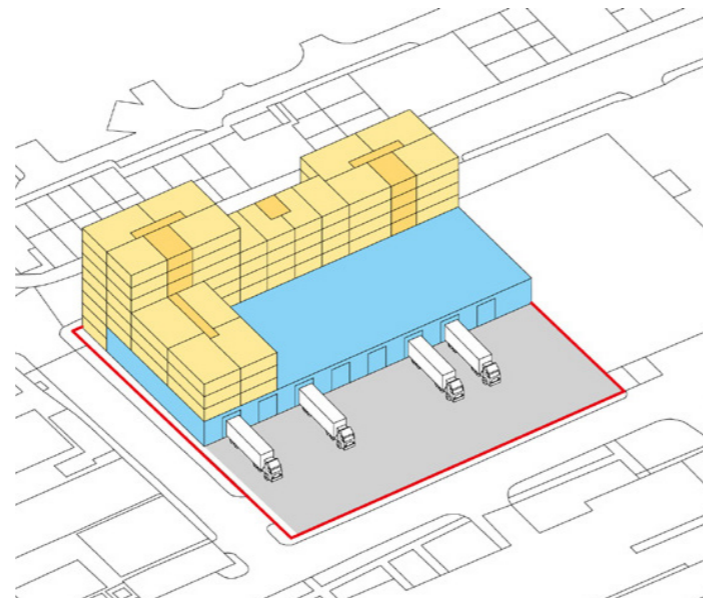

Option A

- Ground floor medium industrial unit
- Residential provision stacked above along primary street edge
- Yard located at the back of site providing HGV/LGV access

Reason discounted

- Site would not meet 95% plot ratio requirement of existing industrial space only providing a 45% plot ratio

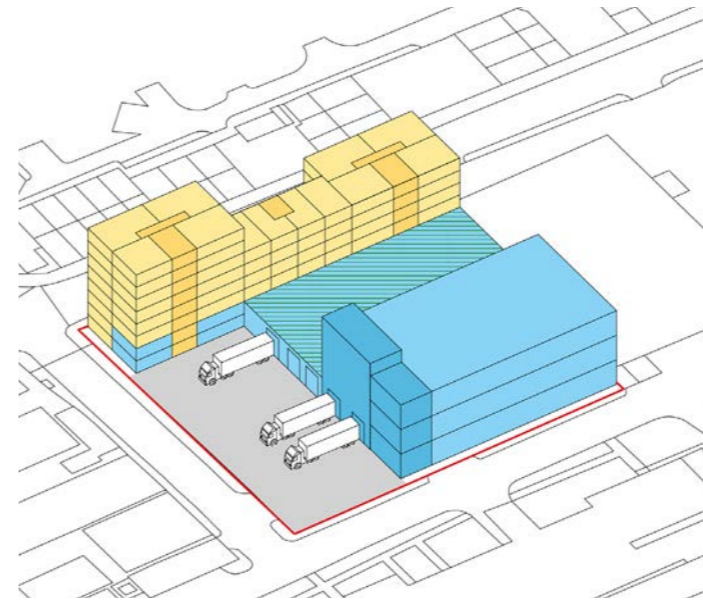

Option B

- Ground floor medium industrial unit
- Residential provision stacked above along primary street edge
- Small industrial units stacked above back of ground floor industrial unit serviced via goods lift
- Yard located on eastern edge of the site providing HGV/LGV access
- Potential for roof-level terrace over the industrial unit providing shared amenity for residential

Reason discounted

- Residential units overlooking yard space

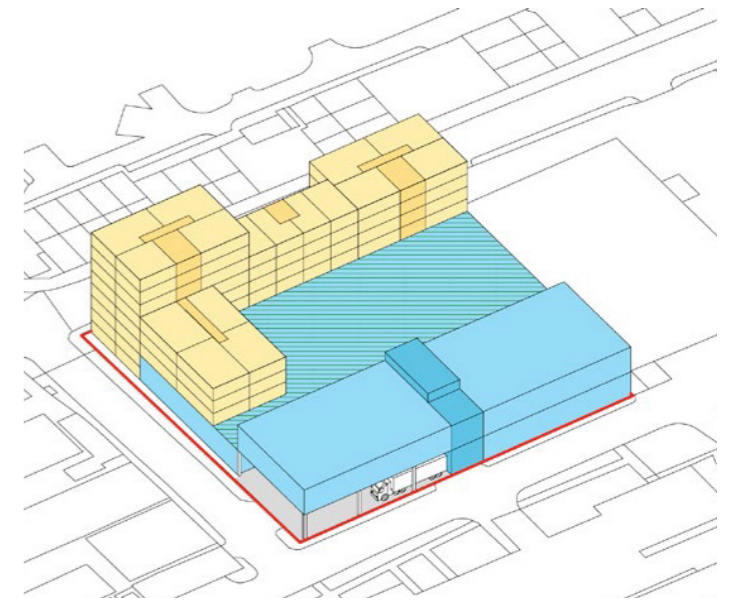

Option C

- Ground floor medium industrial unit
- Residential provision stacked above along primary street edge
- Small industrial units stacked to the rear of site serviced via goods lift
- Yard located at the back of site providing HGV/LGV access
- Potential for roof-level terrace over the industrial unit providing shared amenity for residential

Reason discounted

- Does not provide sufficient yard space for the size proposed industrial development

KEY

- Medium industrial
- Residential units
- Residential cores
- Yard
- ▨ Urban greening



Stacked medium industrial with residential above

Final proposal

The final proposal combines new residential development stacked above a ground-level medium scale industrial unit. To the rear of the site, smaller scale units are stacked above each other and serviced via goods lifts. A roof-level terrace over the industrial unit below provides shared amenity for the new housing, whilst ancillary uses such as offices and cycle parking act as a buffer between the residential and industrial.

KEY

1. Service yard providing HGV access to industrial workspace
2. Shared pedestrian entrance to industrial workspace and residential units
3. Pedestrian entrance to upper level industrial workspace
4. Two goods lifts provide upper floors with access to service yard below
5. Urban greening above industrial workspace provides amenity space for residential accommodation
6. Urban greening above eastern wing of residential units

KEY

- Medium industrial
- Residential units
- Residential cores
- Yard
- ▨ Urban greening
- ▲ Vehicular site entrance
- ▲ Pedestrian entrance

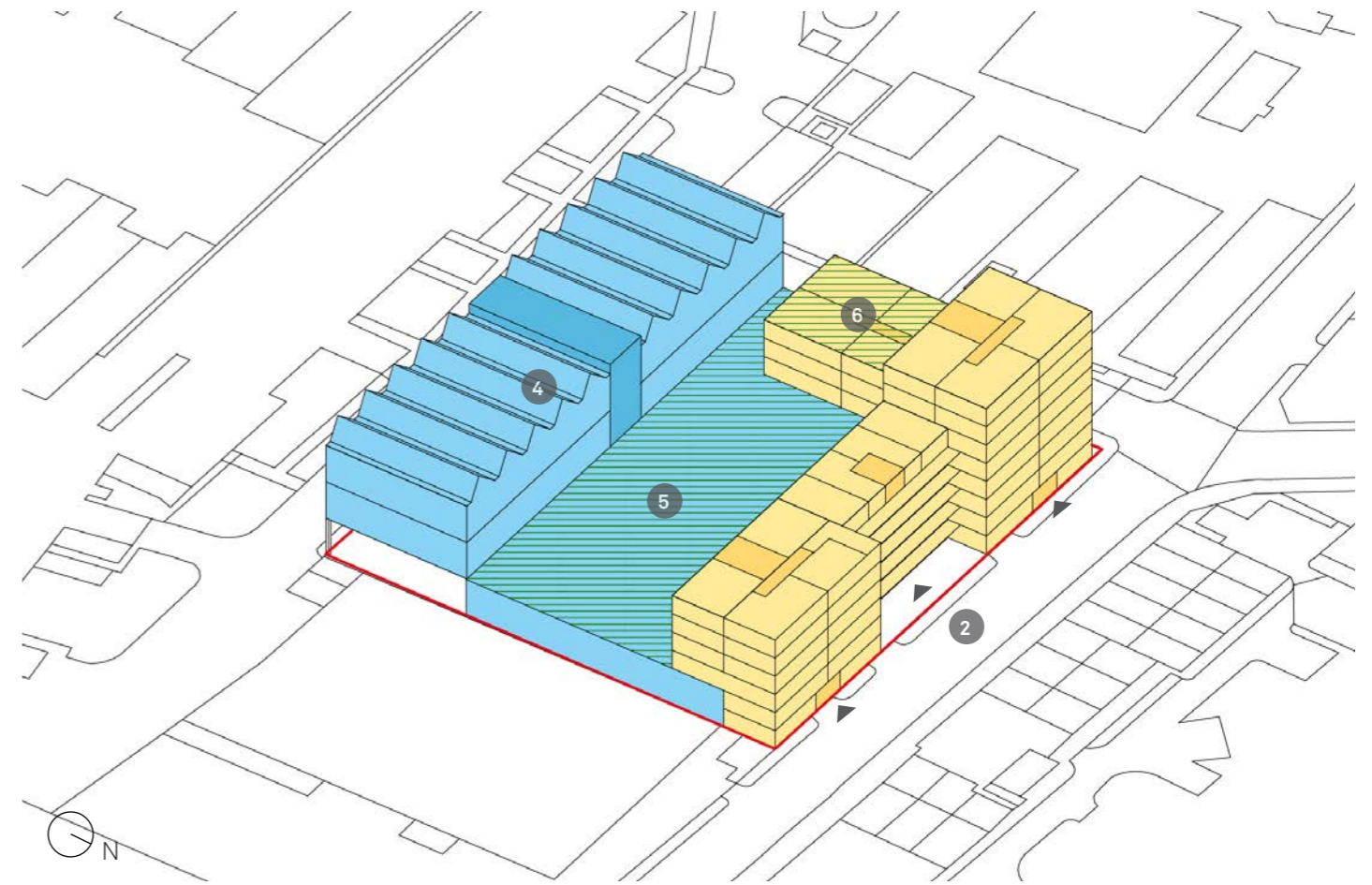

Stacked medium industrial with residential above

Plot size	5,162 m ²
Residential units	76
Medium industrial (including all circulation)	5,320 GFA m ²
Ground floor unit	2,432 m ²
Upper floor units	608 m ²
Structural grid	
Medium industrial	16x8m
Small industrial	19x8m
Residential	8x8m
Floor loadings	
Ground floor	25kN/m ²
Upper floors	7.5kn/m ²
Yard space	1,408 m ²
Industrial parking required	0 spaces
Residential parking required	0 spaces
Parking provided	0 spaces
Disabled parking required	2 spaces
Disabled parking provided	2 spaces
Cycle parking required	177 spaces
Cycle parking provided	177 spaces
Urban greening factor	0.31
Plot ratio	103%

- KEY
- Medium industrial
 - Ancillary office
 - Residential units
 - Residential cores
 - Yard
 - Cycle Parking
 - ⚡ Acoustic mitigation

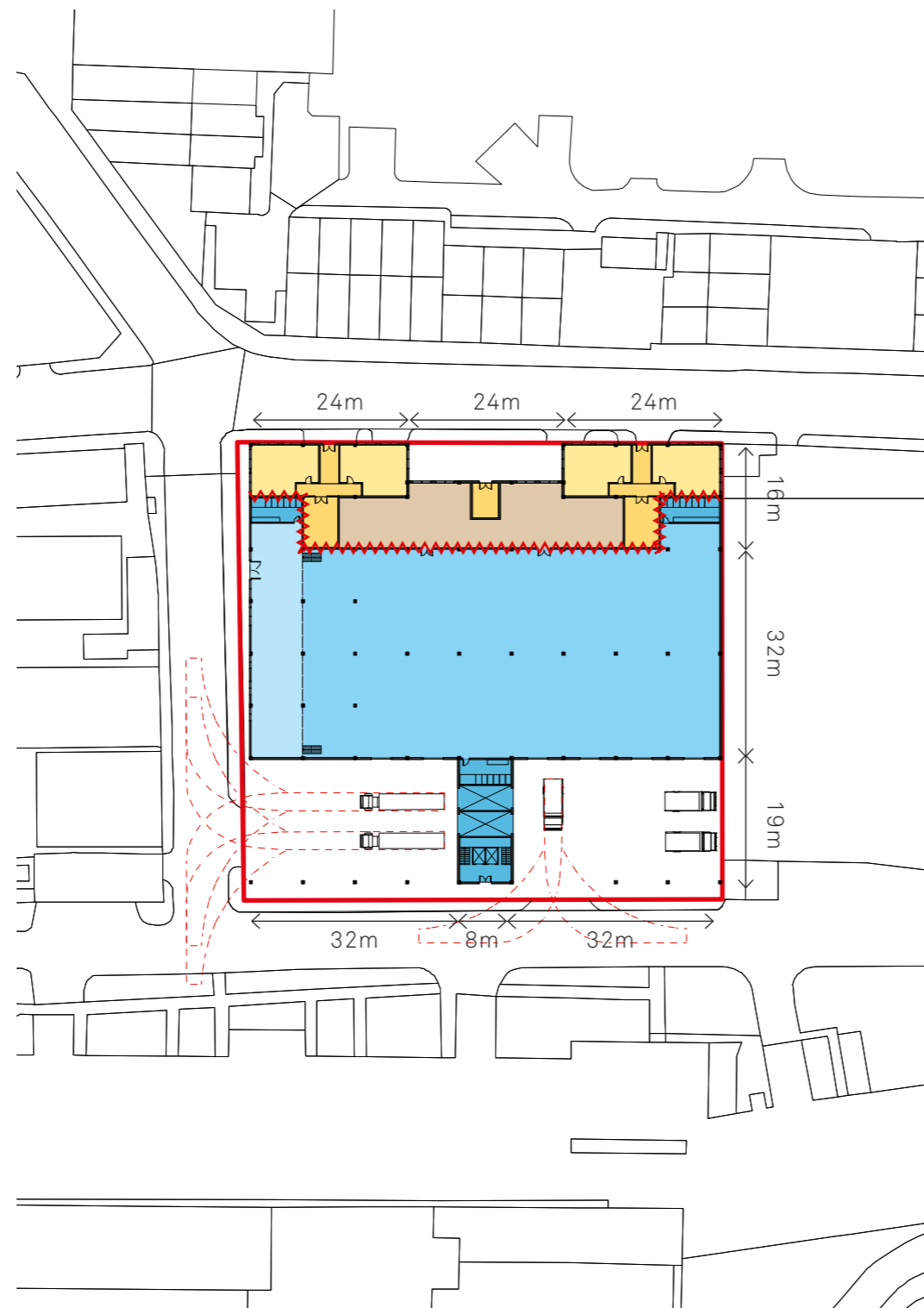

Ground Floor Plan

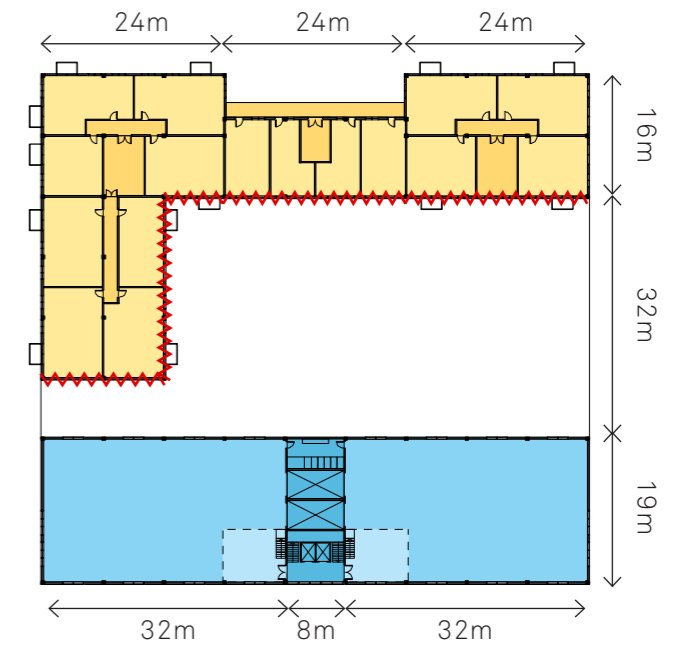

Second Floor Plan



Stacked medium industrial with residential above

Facade treatment

Brick elevations are proposed in order to contribute to a positive neighbourhood quality, in particular in relation to the proposed and adjacent residential accommodation. Different coloured brickwork allows for distinction between residential, medium scale and small scale industrial uses.

KEY

1. Masonry brick wall
2. Glazing with aluminium frames
3. Steel railing balustrades
4. Wall mounted signage
5. Roller shutter doors to goods lifts
6. Steel gate to yard
7. Green roof providing amenity space for residents

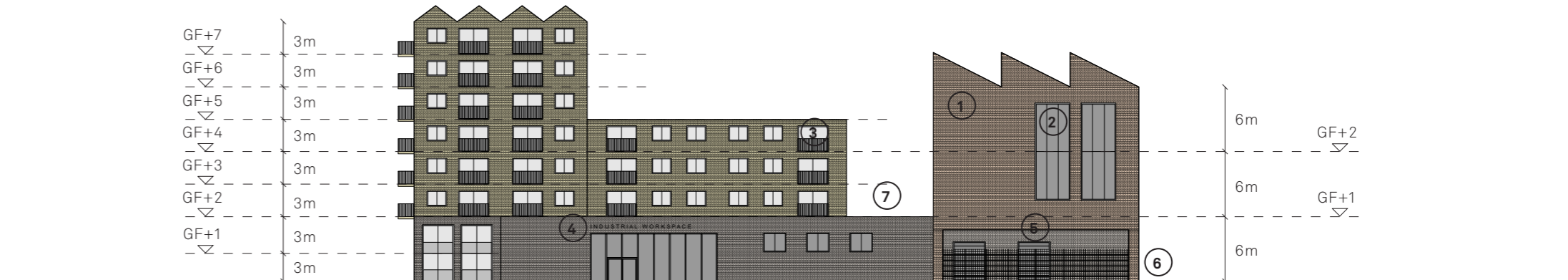
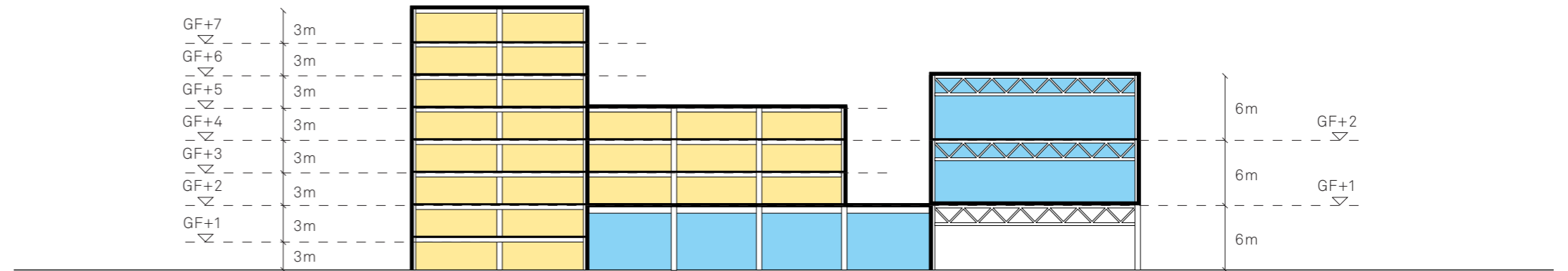

0 10m



RCA Sackler Building, Haworth Tompkins



Newport Street Gallery, Caruso St John



Five Courts Houses, Matthew Gribben Architecture



Vitsø HQ, Vitsø and Martin Francis

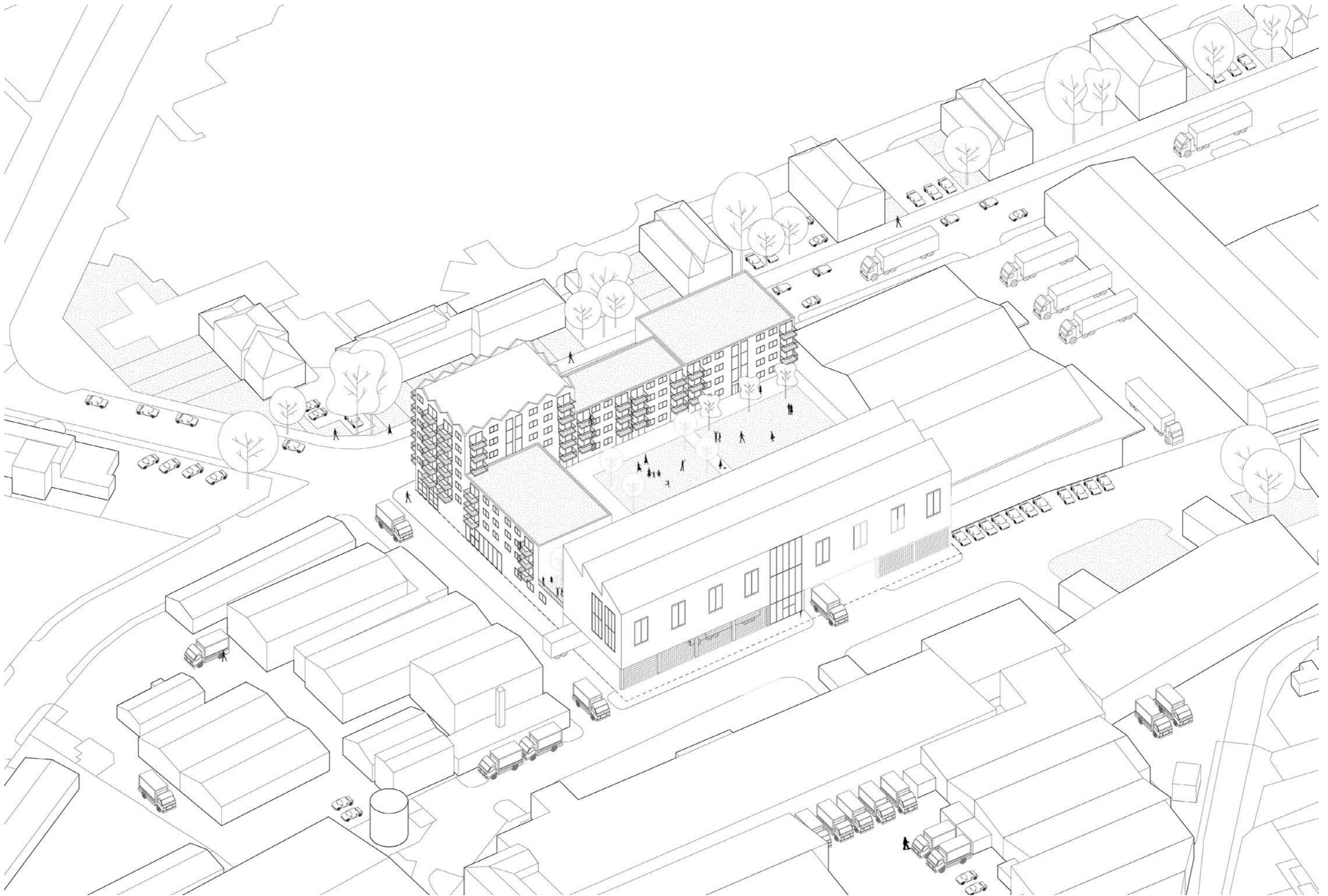

Stacked medium industrial with residential

Stacked medium industrial with residential above

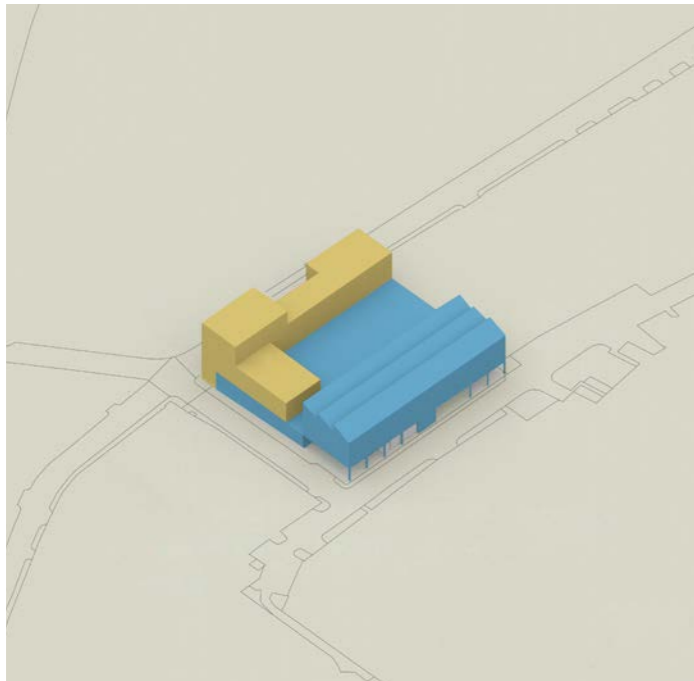

Industrial intensification

'No net loss of industrial floorspace' on small sites with plot ratios significantly higher than 65% can be difficult to achieve with stacked medium industrial co-located with residential

Existing plot ratios significantly higher than 65% can be difficult to achieve on small sites with stacked medium industrial and residential due to difficulty in providing ground floor industrial combined with residential access and industrial yard space.

Goods lifts are more efficient than ramps on small sites

Ramps offering HGV/LGV access to upper level industrial floorspace take up a large proportion of a small site. Instead, goods lifts can provide an opportunity for stacking and significantly increase industrial floorspace.

Shared goods lifts limit both the scale and quantity of stacked units on small sites

Shared goods lifts to upper level units limit stacked provision due to a preference for dedicated lifts for individual businesses or minimal sharing of lifts. Two or three levels of stacked provision may be a reasonable limit for shared goods lifts on small sites as upper level units are currently uncommon and occupiers may be hesitant to take on this type of space. However, international examples show the possibility for further stacking.

Shared yards optimise limited space on small sites

A shared yard offers efficient HGV/LGV access to ground floor with good lift access to upper level industrial floorspace whilst maximising ground floor development.

Small sites may be more efficient and viable with land assembly

Small sites may not easily accommodate stacked medium industrial development and may require land assembly to increase spatial efficiency.

Lower floor loadings on upper floors can significantly reduce build costs

By reducing upper level floor loadings to be appropriate for smaller workshops, studio and light industrial use only on upper floors, can significantly reduce build costs. The high floor loadings associated with general industrial and logistics use can be more cost effectively provided for on ground floors to help reduce build costs.

Residential co-location

Opportunity for residential development providing positive street frontage along main road

Stacked medium industrial allows for opportunity of residential development at the front of the site, providing positive street frontage.

Access from more than one side of the site is an advantage

Access from three sides of the site allows for positive frontages to respond to the differing uses; residential, medium industrial and stacked small industrial. It also provides better separation between pedestrian, cycle and vehicle access.

Location of residential cores limits residential development

Locating residential cores away from industrial access and movement limits residential development around the perimeter of the site. Additionally, residential fire requirements limit the development scale from cores.

Stacking accommodation above industrial can compromise floorspace below

Stacking accommodation above industrial space requires additional support columns that reduce the flexibility of the industrial space below. Ancillary uses such as office space and cycle parking can be efficiently located in the areas to minimise impact on occupiers.

Ancillary uses can provide a buffer between industrial and residential uses

Ancillary uses such as cycle parking, residential servicing and industrial office space can provide a both horizontal and vertical acoustic mitigation between industrial and residential uses.

Top lit industrial space overcomes overlooking from industrial to residential provision

Roof lights allow natural light into upper level industrial space whilst mitigating overlooking issues.

Additional design factors

Significant green roofs are required to meet urban greening requirements

An urban greening factor of 0.3 for industrial uses (as outlined in Draft London Plan 2017) can be achieved by assuming an extensive green roof with a minimum settled depth 80mm for substrate factor 0.7. Other urban greening measures might be feasible such as green walls, permeable paving and tree planting in open areas which are not required for operational yard space.

Green roofs can provide amenity space for residential units

Green roofs required to meet urban greening requirements can provide amenity space for residential units whilst offering an improved visual outlook above ground floor medium industrial unit.

Lack of car parking provision required increases development opportunities

The location of the site in an Inner London Opportunity Area means that development can be car-free (as outlined in the Draft London Plan 2017).

5.5 Model site 1B

Stacked workshops/studios with residential above

Development options

A series of development proposals testing stacked workshop and studio provision combined with new residential development. Models test the quantity of industrial and residential provision, location of service cores, vehicle access and service yards.

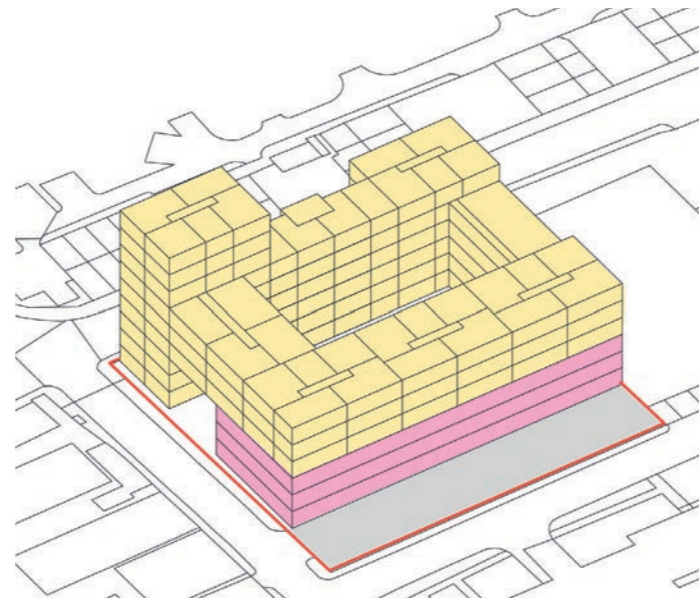

Option A

- Multi-level workshop/studio provision to rear of site with LGV service access
- Residential provision to front and western edge of site ensures positive street frontage
- Central courtyard amenity space for residential

Reason discounted

- Residential provision above studio and workshops results in the doubling of cores

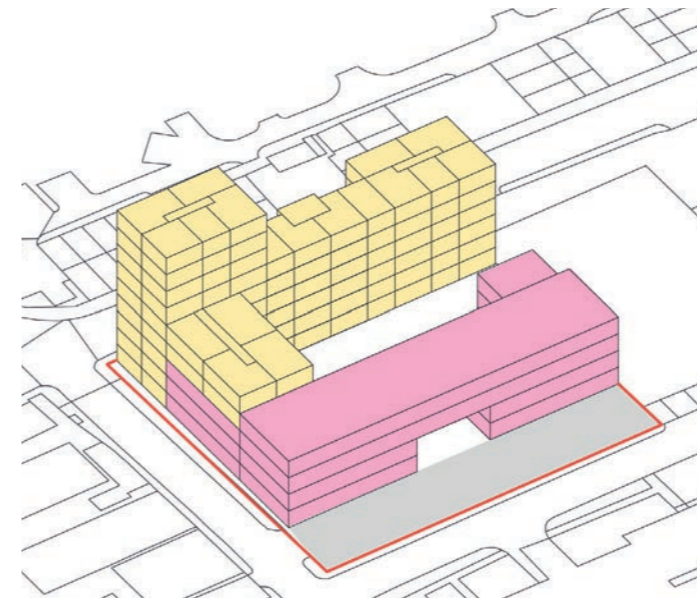







Option B

- Multi-level workshop/studio provision to rear of site with LGV service access
- Residential provision to front and western edge of site ensures positive street frontage
- Central courtyard amenity space for residential

Reason discounted

- Inefficient use of central courtyard for residential use and rear service yard for industrial use

KEY

-  Workshops and studios
-  Goods lift
-  Residential units
-  Residential cores
-  Yard
-  Circulation
-  Urban greening

Stacked workshops/studios with residential above

Final proposal

The final proposal is organised around a central shared yard activated by workshop and studio space. Multi-level light industrial units with high ceilings can be flexibly configured within the overall structural grid. The perimeter of the block provides a positive street frontage to all sides, with a residential block facing onto the primary street edge.

KEY

1. Shared service yard / residential amenity space providing LGV and occasional HGV access to industrial workspace
2. Pedestrian entrance to workshops and studios
3. Pedestrian entrance to residential units
4. Four goods lifts provides upper floors with access to service yard below
5. Urban greening on roofs of industrial and residential accommodation
6. Option for urban greening on deck above yard

KEY

- Workshops and studios
- Goods lift
- Residential units
- Residential cores
- Yard
- Circulation
- Urban greening
- Vehicular site entrance
- Pedestrian entrance

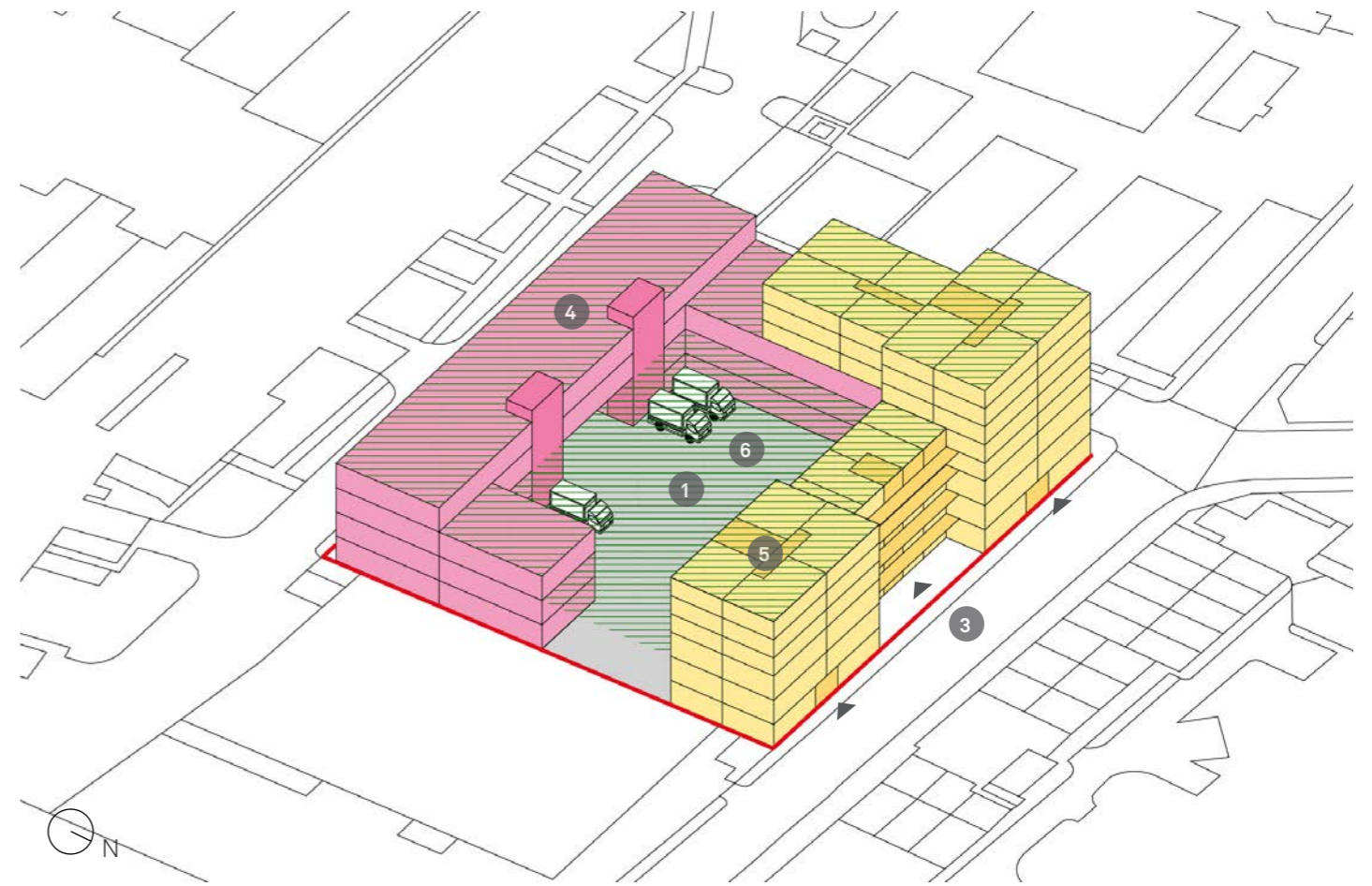

Stacked workshops/studios with residential above

Plot size	5,162 m ²
Residential units	92
Studio/workspace	6,400 GFA m ²
Structural grid	
Workshops and studios	16x8m
Residential	8x8m
Floor loadings	
Ground floor	25kN/m ²
Upper floors	7.5kN/m ²
Yard space	1,664 m ²
Industrial parking required	0 spaces
Residential parking required	0 spaces
Parking provided	0 spaces
Disabled parking required	2 spaces
Disabled parking provided	2 spaces
Cycle parking required	161 spaces
Cycle parking provided	161 spaces
Urban greening factor	0.34
Plot ratio	124%

- KEY
- Workshops and studios
 - Goods lift
 - Potential unit division
 - Residential units
 - Residential cores
 - Yard
 - Circulation
 - Cycle Parking
 - Acoustic mitigation

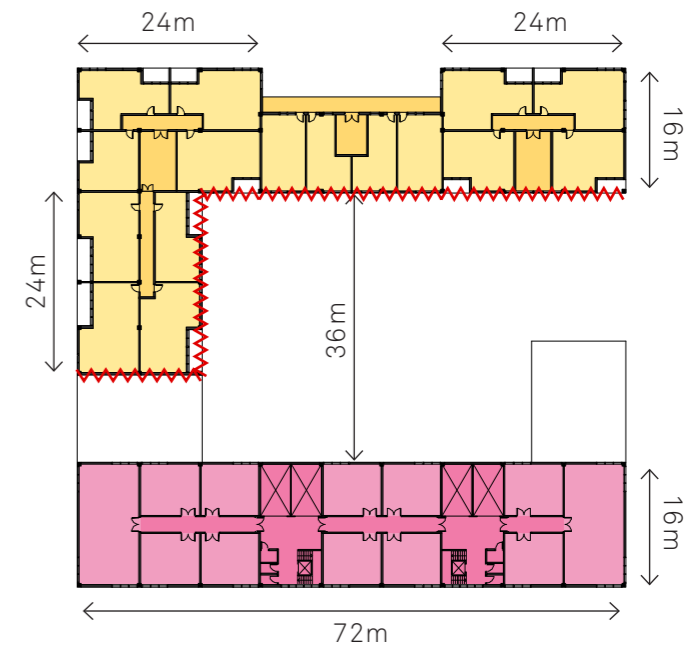
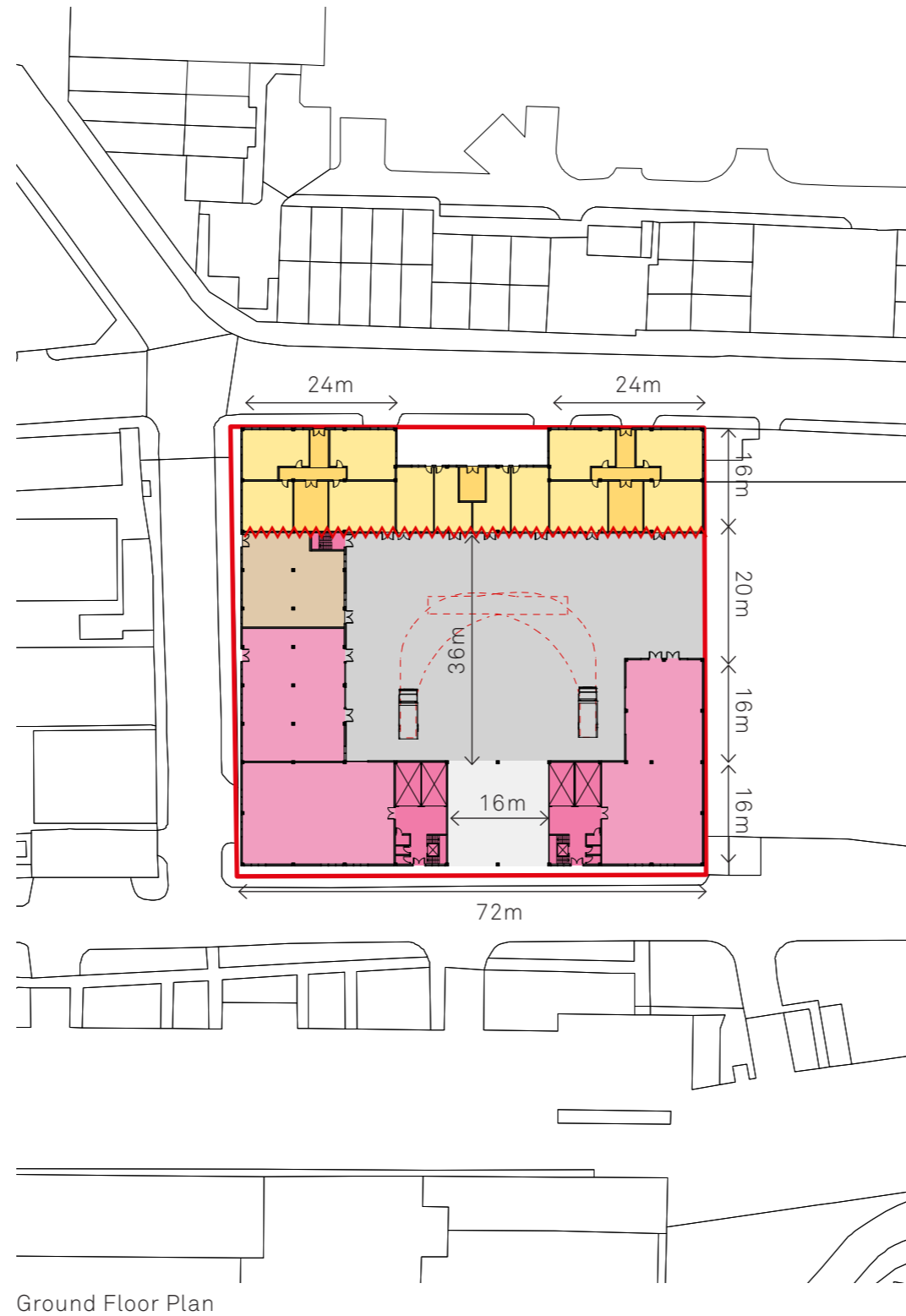

Stacked workshops/studios with residential above

Facade treatment

The brick facade treatment is appropriate for the residential context whilst an expressed structural frame responds to the industrial character of the surrounding area.

KEY

1. Metal cladding to express structural frame
2. Masonry brick infill walls
3. Perforated brick wall
4. Glazing with aluminium frames
5. Glazing with aluminium frames and lower panels
6. Steel railing balustrades
7. Green roof providing amenity space for residents

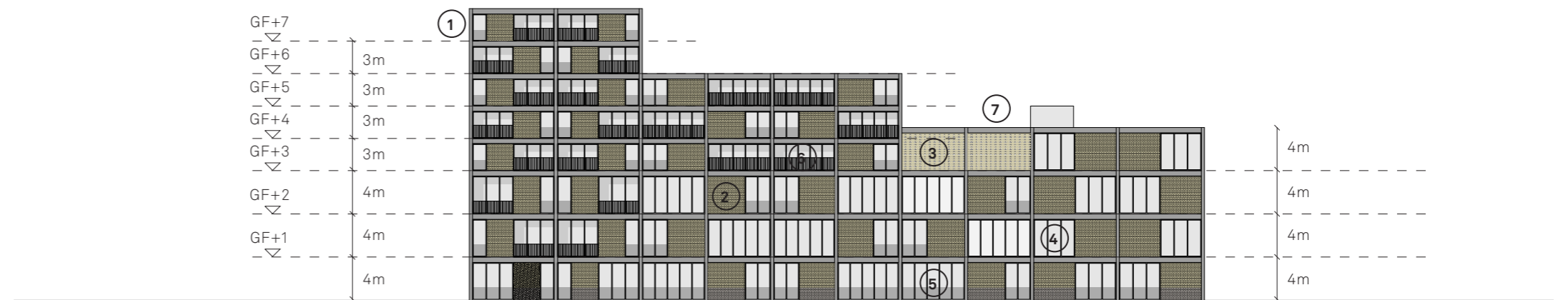
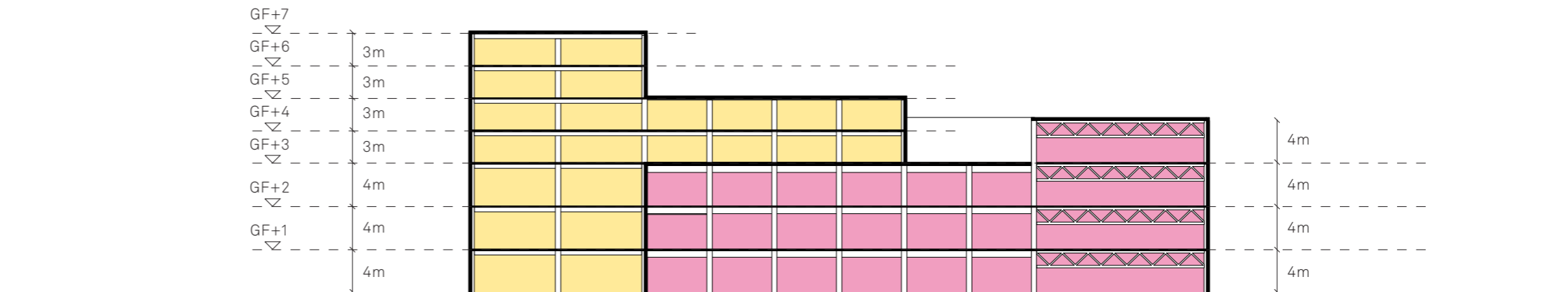

0 10m



Expressed structural framing



Smithdon High School, Peter and Alison Smithson



Ai Weiwei Studio, Ai Weiwei



Ai Weiwei Studio, Ai Weiwei

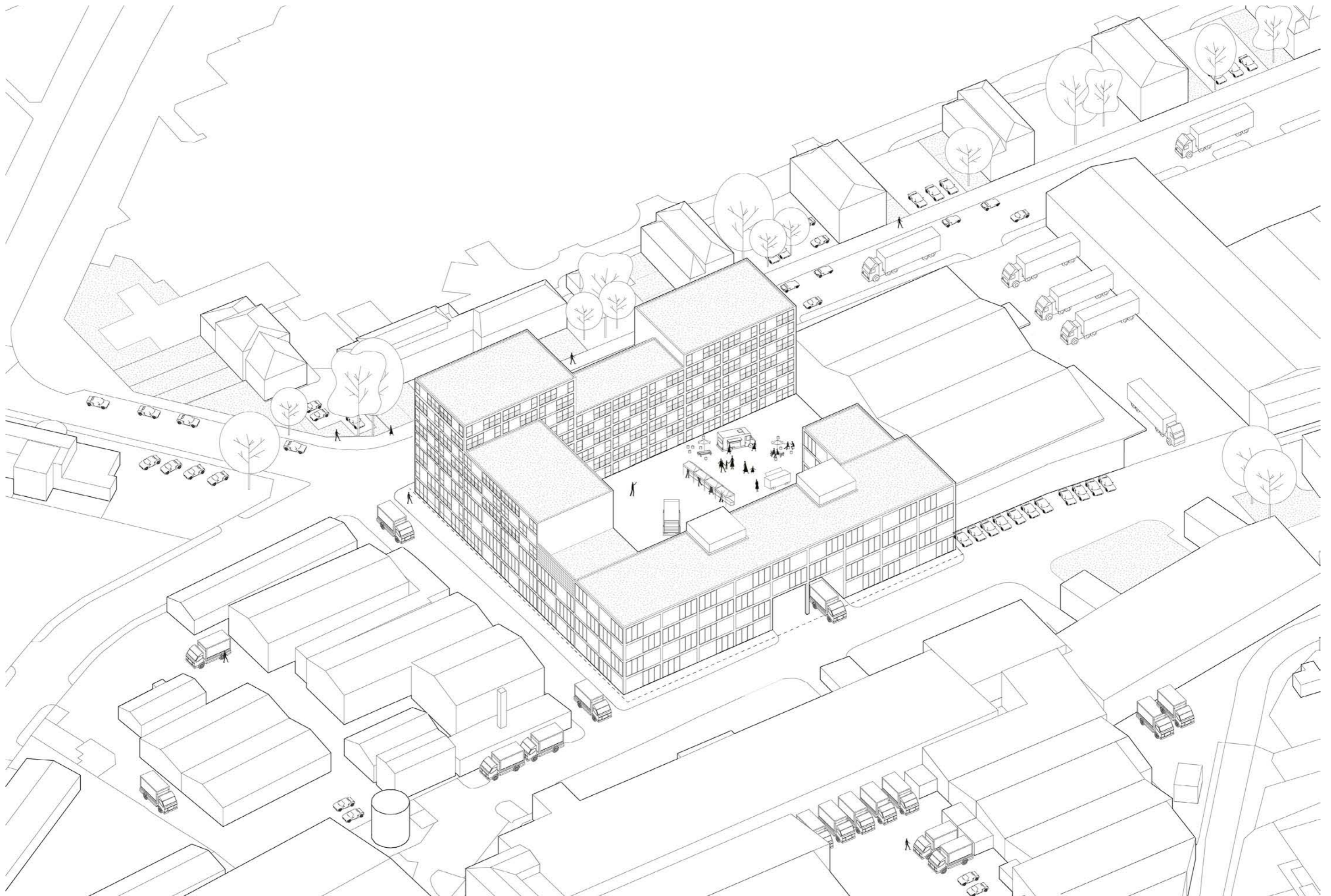

Stacked workshops and studios with residential

Stacked workshops/studios with residential above

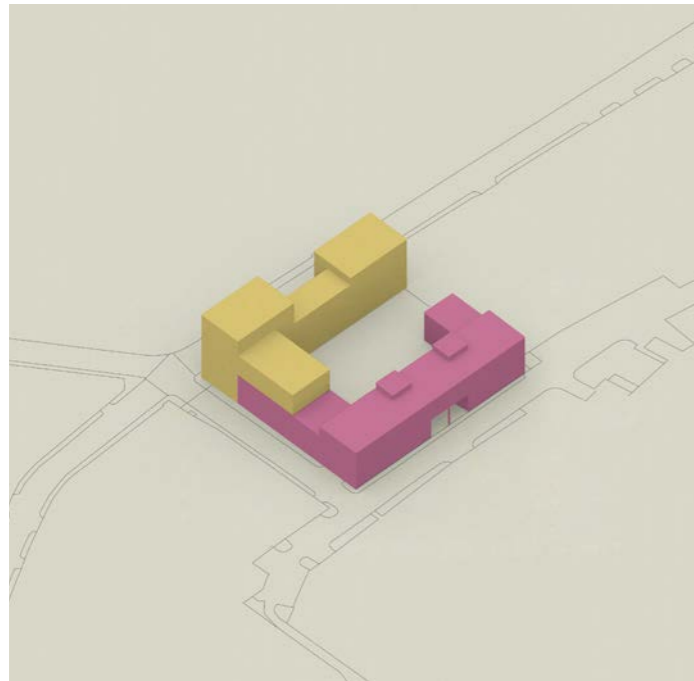

Industrial intensification

Plot ratios greater than 65% can be easily achieved on a small site with stacked workshop/studios

Higher plot ratio can also be easily achieved with workshop/studio space. This is due to the opportunity for up to 4 floors of stacked provision with servicing via shared goods lifts and service yard, maximising the efficiency of the site.

Courtyard block provides positive frontage around perimeter of site

Situating a yard in the centre of the block allows positive frontages around the perimeter of site. It also provides opportunity for multiple access points from the street.

A spanning structure allows for flexibility in unit sizes internally

A spanning structural grid provides flexibility in unit sizes with the potential for subdivision and internal corridors.

Stacked workshop/studios have higher build costs than industrial space

Workshops/studios have higher build costs than stacked medium industrial due to increased structure and servicing requirements. This could affect the viability of stacked workshop/studio provision.

Shared yards allow flexibility for both industrial servicing and residential amenity but could create conflict between users

Shared yards provide the opportunity for both servicing of workshops and studios as well as amenity space for residents. Measures to mitigate acoustic and other environmental issues for the residential units would need to be considered such as non-opening windows, triple glazing, winter gardens and decking. Examples of shared yards include the shared live/work typologies in Hackney Wick.

Residential co-location

Opportunity for residential development providing positive street frontage along main road

Stacked workshops/studios allow for opportunity of residential development at the front of the site, providing positive street frontage along main roads.

Additional decking above service yard could mitigate associated visual, acoustic and other environmental issues

A lightweight decking structure could be built above central courtyard to mitigate acoustic and visual issues associated with industrial servicing, minimising conflict with residential units above.

Compatibility between studio/workshops and residential as they are on the same structural grid

Workshops/studios can be located below residential units and on the same structural grid with a minimal decrease in flexibility.

Stacking residential directly above multi-storey workshops/studios requires multiple service cores

A more efficient mixed use separates multi-level workshop/studios from residential provision, with overlap only where accessibility is possible from individual service cores.

Residential units adjacent to workshops/studios benefit from higher floor to ceiling heights

Residential units adjacent to workshops/studios benefit from an increase in ceiling height on lower levels to ensure accessibility from residential cores at upper levels.

Additional design factors

Significant green roofs are required to meet urban greening requirements

An urban greening factor of 0.3 for industrial uses (as outlined in Draft London Plan 2017) can be achieved by assuming an extensive green roof with a minimum settled depth 80mm for substrate factor 0.7. Other urban greening measures might be feasible such as green walls, permeable paving and tree planting in open areas which are not required for operational yard space.

Lack of car parking provision required increases development opportunities

The location of the site in an Inner London Opportunity Area means that development can be car-free (as outlined in the Draft London Plan 2017).

5.6 Area 2
Suburban London

Existing conditions

Plot size	17,630 m ²
Industrial space	7908 GFA m ²
No. of storeys	1 storey
Yard space	5000 m ²
Parking	45 spaces
Plot ratio	45%

Industrial land designation

— Strategic Industrial Location

Existing uses

— B8 (Storage and distribution)

Access

— Access from one side only

Context

— Centrally located within SIL
— Surrounded by industrial use

Transport connections

— PTAL 1B
— Well connected to the strategic road network

KEY

- Industrial space
- Yard
- Car Parking
- Circulation

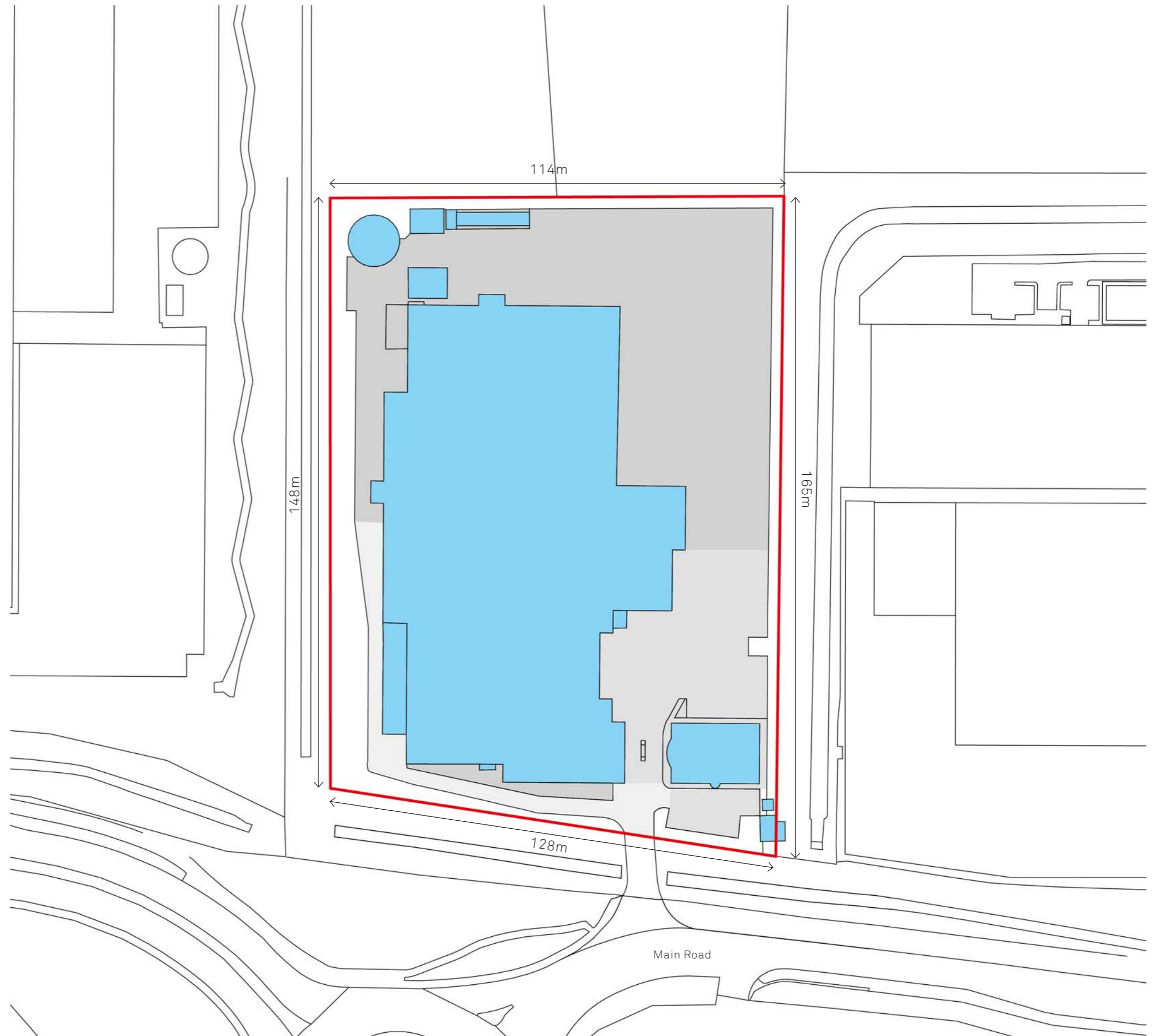
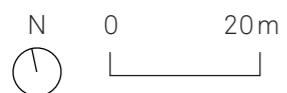

Ground Floor Plan

5.7 Model site 2

Stacked large industrial

Development options

A series of development proposals testing stacked large industrial provision. Models test number of levels of stacked provision, location of service yards, car parking and ramps to upper levels as well as pedestrian movement throughout scheme.

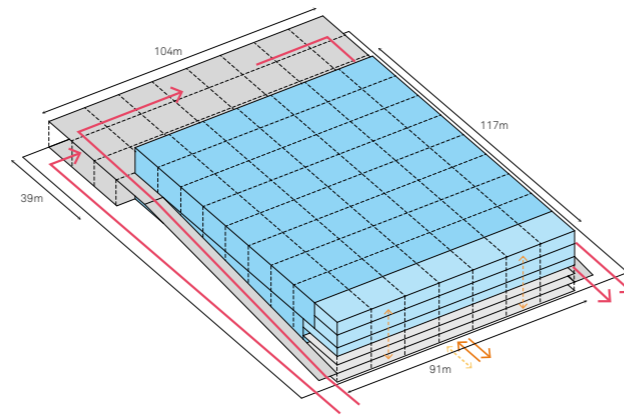

Option A

- Two floors of large industrial provision
- Yards located at the rear of the site with ramps providing HGV access to upper level unit
- Car parking and ancillary office located at front of site allowing efficient access to industrial space

Reason discounted

- Inefficient yard access, not possible to circulate from yard to yard
- Car park would need to be designed to provide positive street frontage

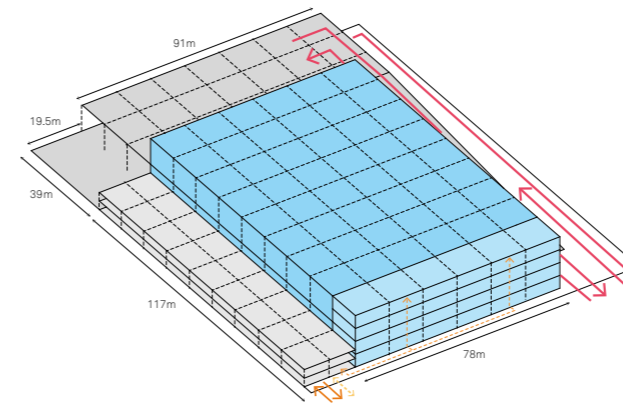

Option B

- Two floors of large industrial provision
- Yards located at the rear of the site with ramps providing HGV access to upper level unit
- Car parking located on western edge of site with ancillary office located to the front of the site providing positive street frontage

Reason discounted

- Inefficient yard access, not possible to circulate from yard to yard
- Long distance to travel from car park to ancillary office and industrial space

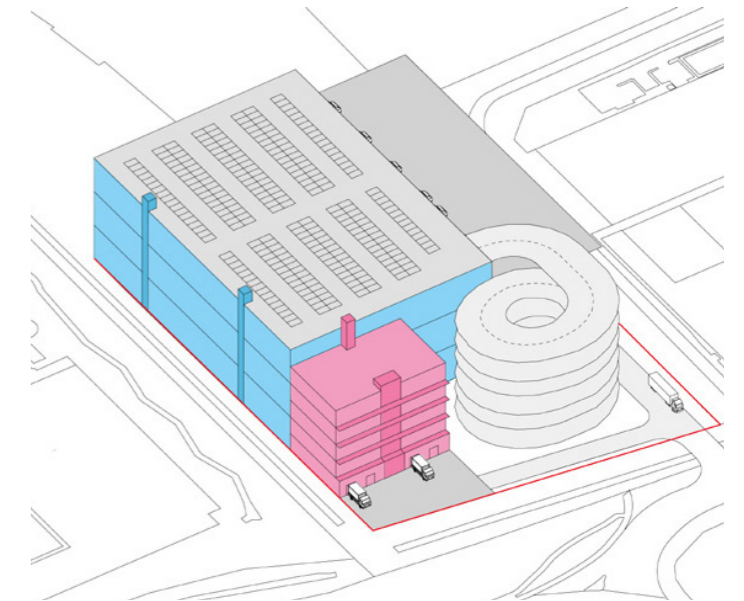

Option C

- Three floors of large industrial provision
- Yards located on the eastern edge of site with a spiral ramp providing LGV access to upper level units and rooftop car park
- Stacked studios and workshops occupy leftover space to the front of the site, serviced via goods lifts

Reason discounted

- Spiral ramp too small to accommodate HGV access to upper level units
- Spiral ramp occupies a large proportion of site, a much larger site necessary for efficient use
- Strong demand for large industrial provision in suburban location but unclear of sufficient demand for small industrial space

KEY

- Ancillary office
- Large industrial
- Industrial core
- Workshops and studios
- Goods lift
- Yard
- Car Parking
- Circulation

Stacked large industrial

Final proposal

The final proposal illustrates a three-storey approach to larger scale industrial provision. Ramps wrap around the building providing heavy goods vehicle access to the upper level units and service yards. The roof space is used for car parking, a likely necessity for large scale industrial development which are often located in less accessible industrial areas.

KEY

1. Ramps to upper level service yards and staff car park
2. Service yards providing HGV access to upper level workspace
3. Staff car park with pedestrian lifts to workspace below
4. Option for urban greening above car park

KEY

- Large industrial
- Industrial core
- Yard
- Car Parking
- Circulation
- ▨ Urban greening
- ▲ Vehicular site entrance
- ▲ Pedestrian entrance

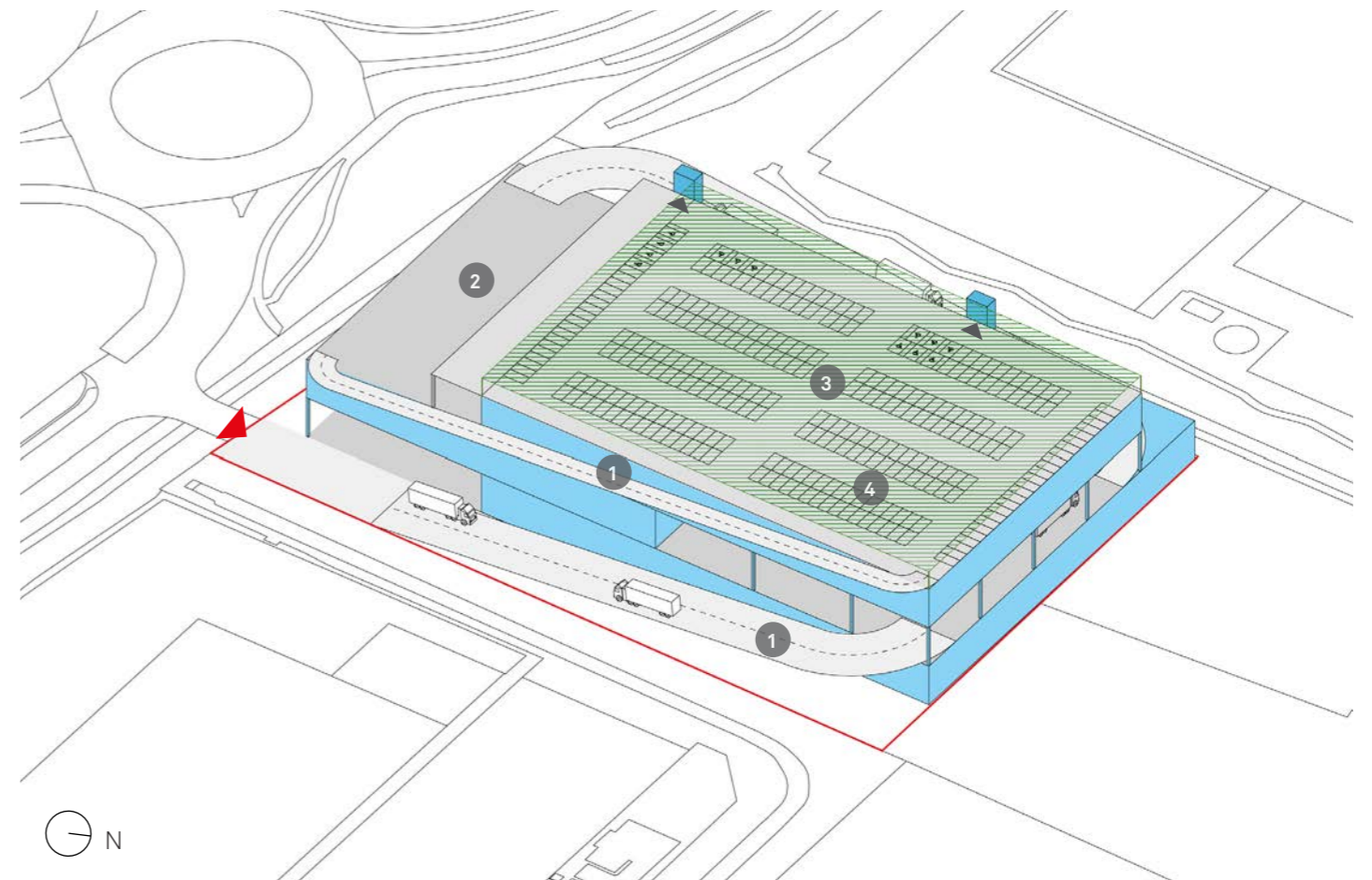
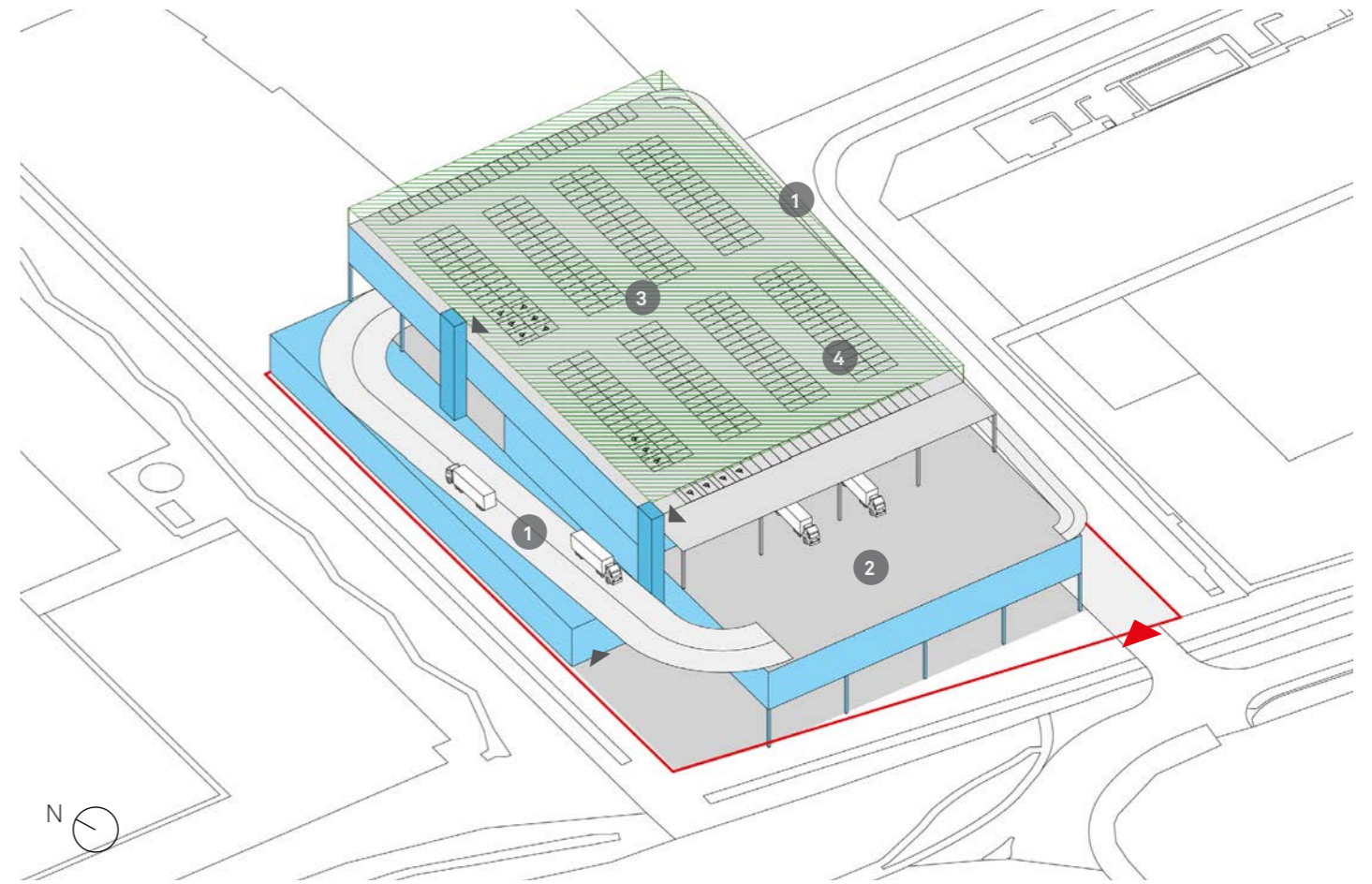

Stacked large industrial

Plot size	17,630 m ²
Large industrial	25,680 GFA m ²
Ground floor unit	10,080 m ²
First floor unit	7,200 m ²
Second floor unit	8,400 m ²
Structural grid	15x16m
Floor loadings	
Ground floor	50kN/m ²
Upper floors	35kN/m ²
Yard space	8,664 m ²
Industrial parking required	267 spaces
Parking provided	297 spaces
Disabled parking required	13 spaces
Disabled parking provided	13 spaces
Cycle parking required	80 spaces
Cycle parking provided	80 spaces
Plot ratio	152%

- KEY
- Ancillary office
 - Large industrial
 - Industrial core
 - Yard
 - Car Parking
 - Circulation
 - Cycle Parking

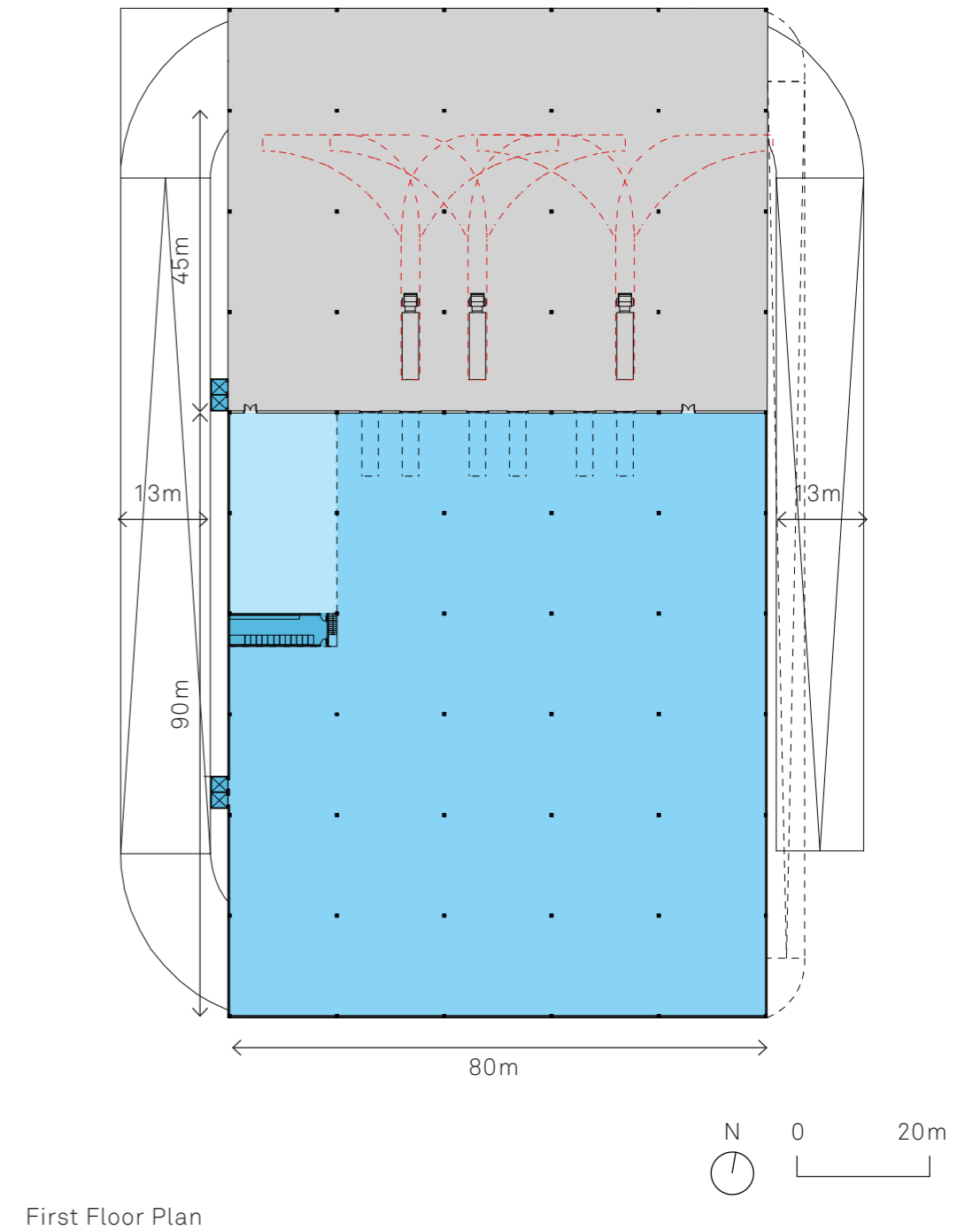
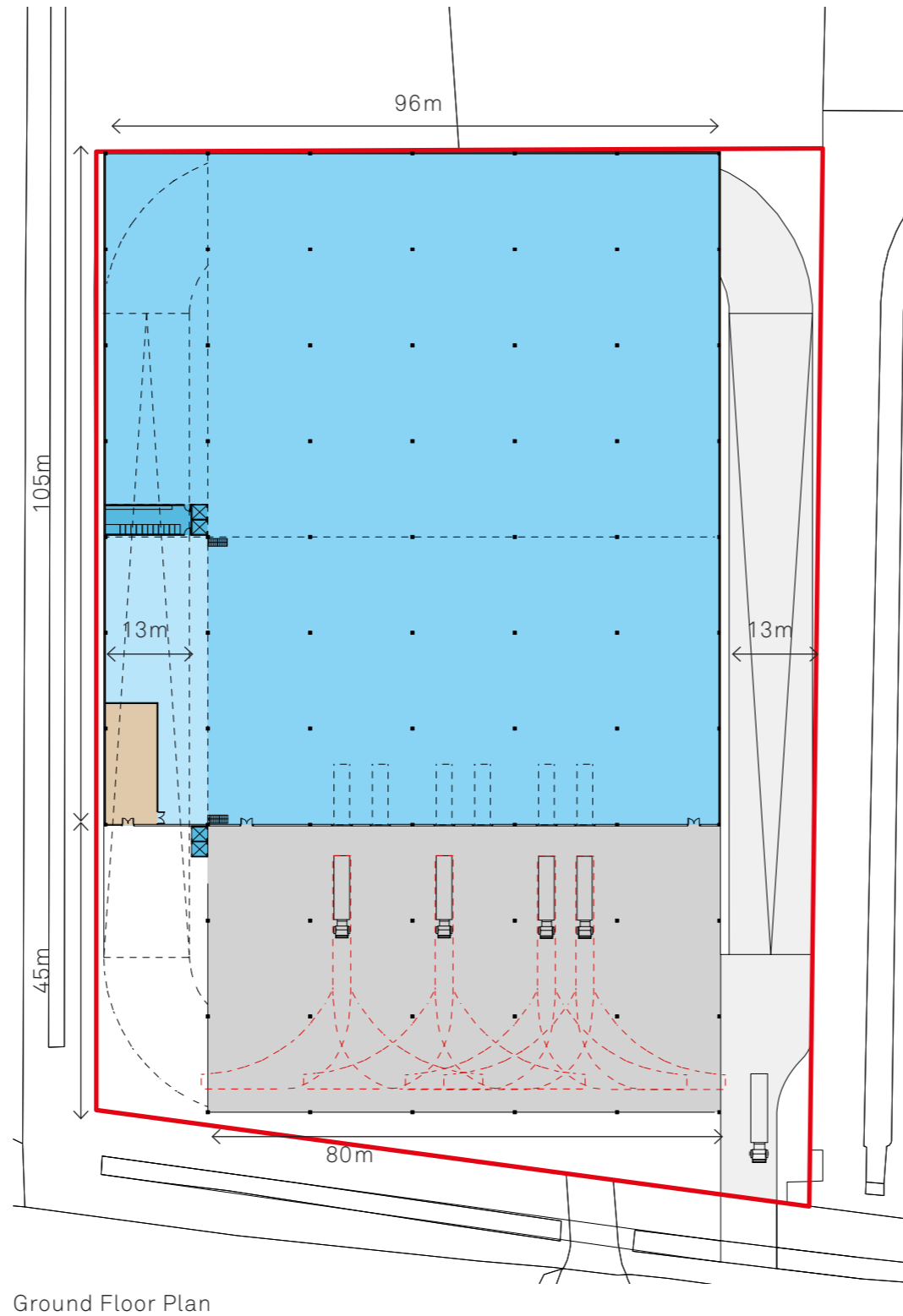

Stacked large industrial

Facade treatment

A facade treatment of light weight corrugated metal and polycarbonate is typical of sheet materials associated with large scale industrial buildings.

KEY

1. Corrugated metal cladding
2. Translucent polycarbonate cladding
3. Perforated metal pedestrian lift shafts
4. Steel frame structure
5. Painted infographic signage
6. Metal balustrade
7. Concrete vehicle ramps
8. Staff and visitor entrances
9. Roller shutter doors

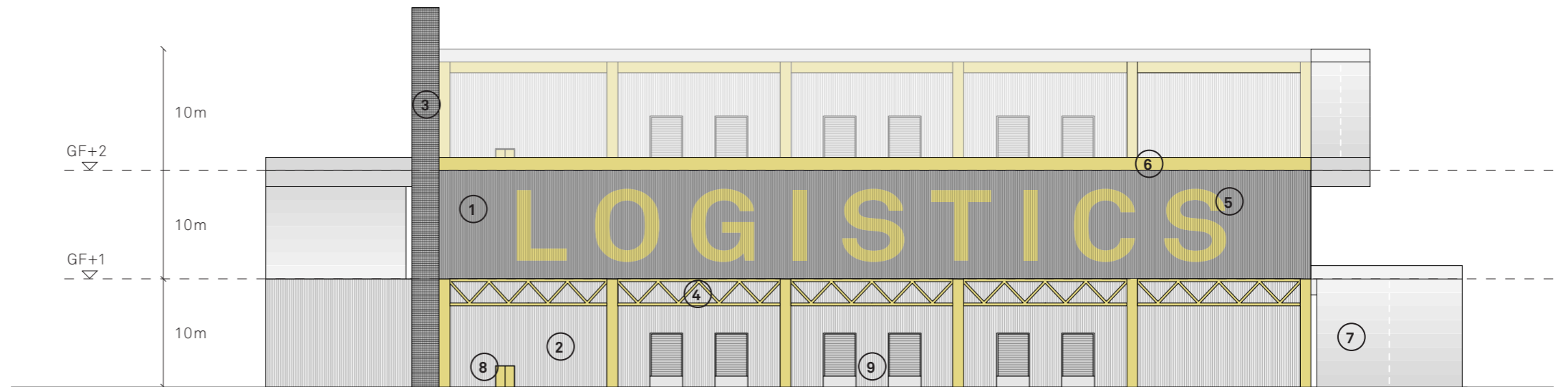
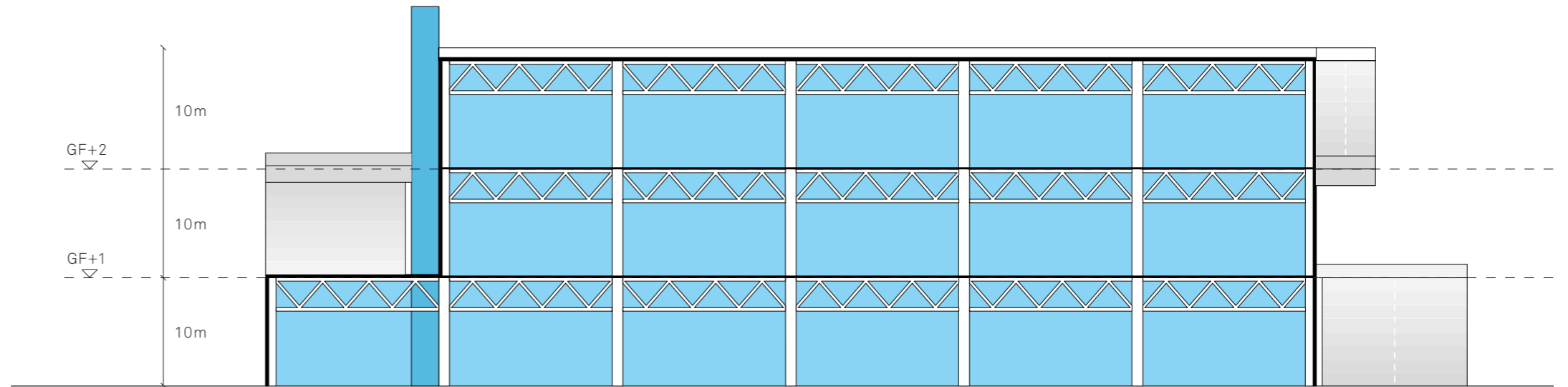

Minnesota Street Warehouse, Jensen Architects



Here East, Hawkins Brown



Here East, Hawkins Brown

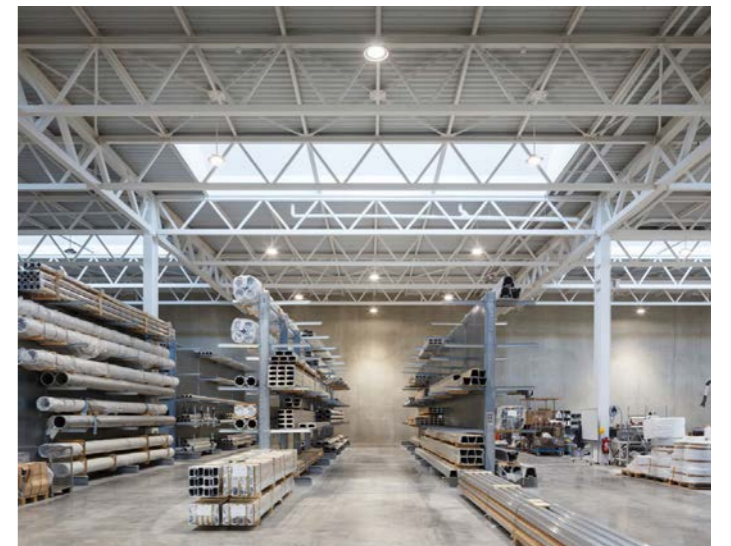

Technilum, Passelac & Roques Architectes

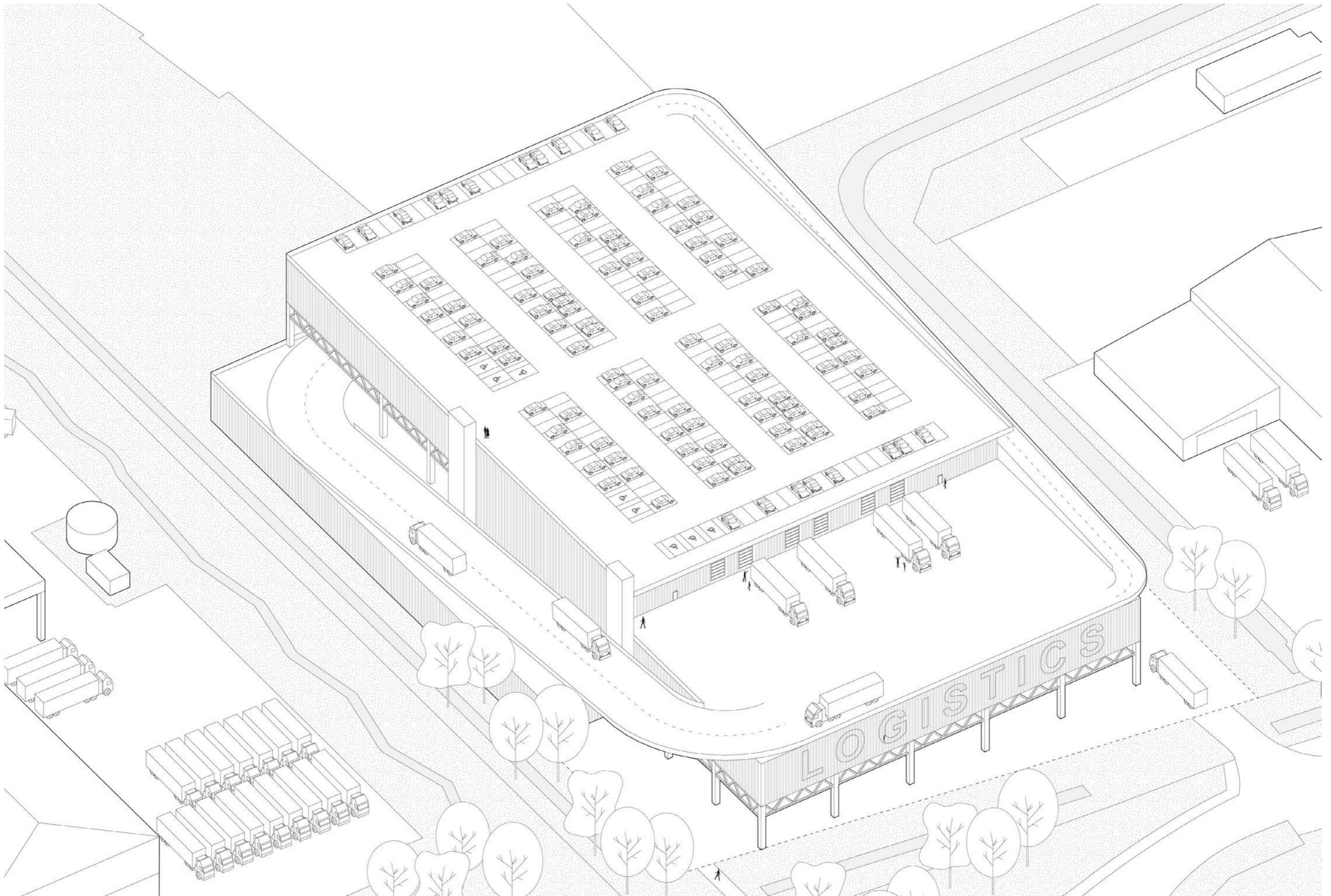

Stacked large industrial

Stacked large industrial

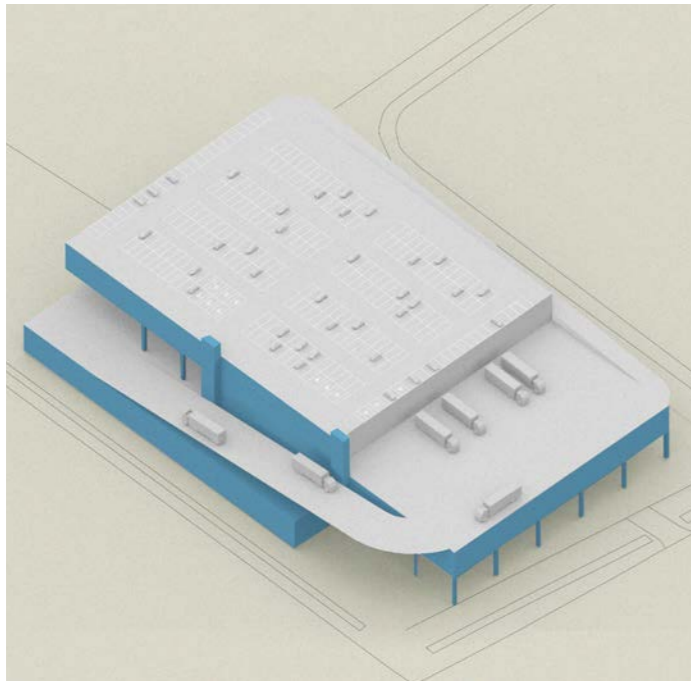

Industrial intensification

Structural grid of 15x16m offers a compromise between structural design efficiency as well as internal and external flexibility

A column spacing of 15-16m for stacked large industrial provision responds to structural design constraints whilst maximising internal user flexibility and offering HGV accessibility to all yard areas.

High upper level floor loadings allow greater range of potential occupiers but result in significant structural requirements that reduce occupier flexibility

High upper level floor loadings allow the potential for both industrial and logistics uses that typically occupy large industrial provision. These floor loading requirements result in truss depths of approximately 3m (reducing floor to ceiling heights) and limit clear spans between columns to approximately 10m, potentially reducing internal flexibility for occupiers.

‘Scissor’ arrangement of service yards with ramp circulation around industrial provision allows efficient movement between levels

Ramps either side of industrial provision requires HGVs to pass along the edge of service yards. Additional depth must therefore be provided to ensure HGVs can manoeuvre within yards without conflicting with vehicles circulating up/down the ramps.

Access limited to only one short edge of the plot reduces opportunity for separation of movement into the site

Only one point of access from the shorter edge of the site reduces opportunity to separate HGV/LGV, car, pedestrian and cycle routes into the site. Access from the longer edge or more than one side significantly increases the opportunity for separation of routes.

HGV access ramps

Maximum ramp gradients limit floor to ceiling heights on a small site (ideally minimum 150m on shortest side of site)

Maximum ramp gradients of 1:10 limit possible floor to ceiling heights on small sites due to constrictions on the maximum possible length of the ramp. Ideally the minimum shortest side of site would be 150m allowing for a straight ramp the length of edge and rising 10m in height and with turning circles either end. This proportional arrangement would also ensure the largest amount of floorspace to fixed ramp costs, maximising cost efficiency and viability.

Straight ramps are more effective on smaller sites than spiral ramps

Spiral ramps take up a large proportion of a small site and potentially leave an awkward shape available for industrial floorspace. Alternatively straight ramps can wrap around the building ensuring a more efficient use of the site and greater usable industrial floorspace.

Spiral ramps are more efficient on larger sites and allow for additional stacking

On larger sites spiral ramps provide more efficient movement between levels as well as greater potential for high rise stacking of industrial floorspace.

HGV ramps significantly increase stacked large industrial build costs

HGV access ramps to upper level provision significantly increase build costs. The larger the rentable floorspace the more these fixed costs can be diluted into the average build cost per square metre.

Additional design factors

Sites with low PTAL can accommodate parking on the roof

High parking requirements can be met by providing car parking space on the roof without any reduction in industrial provision or yard space. However, employee vehicles must share lower level ramps with HGVs accessing industrial units.

Significant green roofs are required to meet urban greening requirements

Rooftop parking and ramped circulation provides little opportunity for a green roof/walls necessary to meet urban greening requirements. An additional lightweight structure above rooftop car park would address this issue, providing potential to meet an urban greening factor of 0.3 for industrial uses (as outlined in Draft London Plan 2017). Other urban greening measures might be feasible such as green walls, permeable paving and tree planting in open areas which are not required for operational yard space.

Pedestrian and cycle circulation around site must be carefully considered

Pedestrian and cycle movement must be carefully considered to minimise conflict with HGV circulation and loading area. Shared circulation cores can provide safe and efficient movement between industrial provision and a rooftop car park.

5.8 Area 3
Urban London

Existing conditions

Plot size	7,280 m ²
Industrial space	3371 GFA m²
No. of storeys	1 storey
Yard space	350 m ²
Parking	32 spaces
Plot ratio	46%

Industrial land designation

— Locally Significant Industrial Site

Existing uses

— B2 (General industrial)

Access

— Access from one side only

Context

- On western edge of LSIS
- Predominantly surrounded by residential use
- Industrial use to the east

Transport connections

— PTAL 4

KEY

 Industrial space

 Yard

 Car Parking

 Circulation

N 0 20m



Ground Floor Plan

5.9 Model site 3

Stacked small industrial with adjacent residential

Development options

A series of development proposals testing stacked small industrial provision adjacent to residential development. Models test quantity of industrial and residential provision, configuration of industrial units as well as vehicle access to service yards.

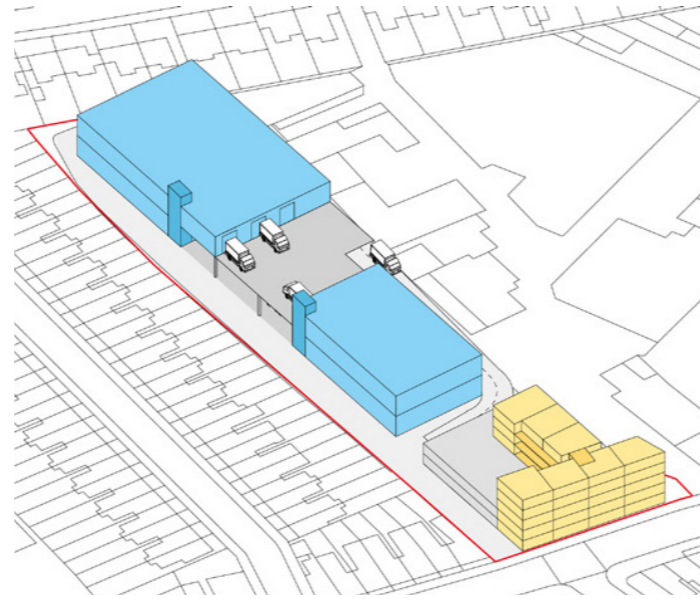

Option A

- Two floors of small industrial provision with ramp access to upper level units
- Shared yards maximise efficiency of servicing to units
- Residential provision located along primary street edge
- Shared industrial and residential car parking in podium of residential development
- Potential for roof-level terrace over podium car park providing shared amenity for residential

Reason discounted

- Yard access difficult and constrained on upper and lower levels
- 65% plot ratio with yard provides little remaining space for residential development at front of site



Option B

- Two storey small industrial provision with goods lift access to upper levels
- No ramp allows greater residential development
- Residential provision located along primary street edge
- Shared industrial and residential car parking in podium of residential development
- Potential for roof-level terrace over podium car park providing shared amenity for residential

Reason discounted

- Difficult HGV manoeuvrability and access within service yards
- Industrial provision mainly provided on upper floors via goods lifts



Option C

- Two floors of small industrial provision with goods lift access to upper level units
- No ramp allows greater residential development
- Larger yard improves HGV manoeuvrability and access within service yards
- Residential provision located along primary street edge
- Shared industrial and residential car parking in podium of residential development
- Potential for roof-level terrace over podium car park providing shared amenity for residential

Reason discounted

- Size of units too large for goods lift to upper floors

KEY

- Medium industrial
- Industrial cores
- Residential units
- Residential cores
- Yard
- Car Parking
- Circulation
- Urban greening

Stacked small industrial with adjacent residential

Final proposal

The final proposal locates residential uses at the front of the site separate from the multi-level industrial units at the rear which are serviced via goods lifts. The residential massing allows for LGV and occasional HGV servicing to the site whilst maximising built floorspace. Car parking for both the industrial and residential provision is located in a ground floor podium within the residential development. On top of the podium a roof level terrace provides shared amenity space for the new housing.

KEY

1. Stacked industrial workspace with LGV access on ground floor
2. Pedestrian access to workspace
3. Pedestrian entrance to residential units
4. Two goods lifts and wide corridors provide upper floors with access to service yard below
5. Staff and residential car park with urban greening above also providing amenity space for residential accommodation
6. Option for urban greening on roof of industrial workspace

KEY

- Medium industrial
- Industrial cores
- Residential units
- Residential cores
- Yard
- Car Parking
- Circulation
- ▨ Urban greening
- ▲ Vehicular site entrance
- ▲ Pedestrian entrance

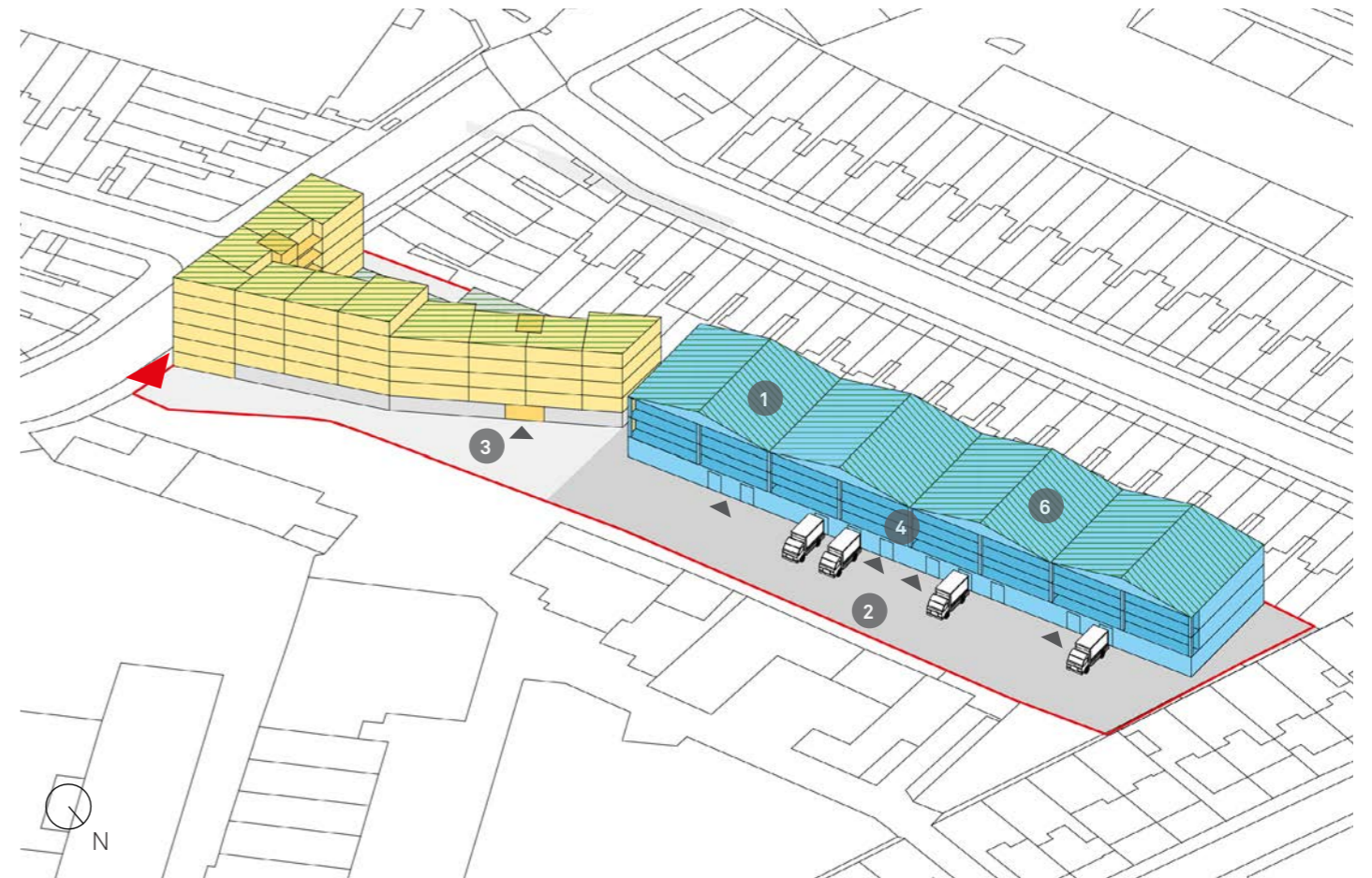

Stacked small industrial with adjacent residential

Plot size	7,280 m ²
Residential units	55
Small industrial (including all circulation)	6,864 GFA m ²
Ground floor units	500-572 m ²
Upper floor units	462-520 m ²
Structural grid	
Small industrial	5.5x13m
Residential	8x8m
Floor loadings	
Ground floor	35kN/m ²
Upper floors	25kN/m ²
Yard space	1,664 m ²
Industrial parking required	69 spaces
Residential parking required	28 spaces
Parking provided	32 spaces
Disabled parking required	5 spaces
Disabled parking provided	5 spaces
Cycle parking required	105 spaces
Cycle parking provided	105 spaces
Urban greening factor	0.36
Plot ratio	95%

- KEY
- Medium industrial
 - Ancillary office
 - Industrial cores
 - Residential units
 - Residential cores
 - Yard
 - Car Parking
 - Circulation
 - Cycle Parking

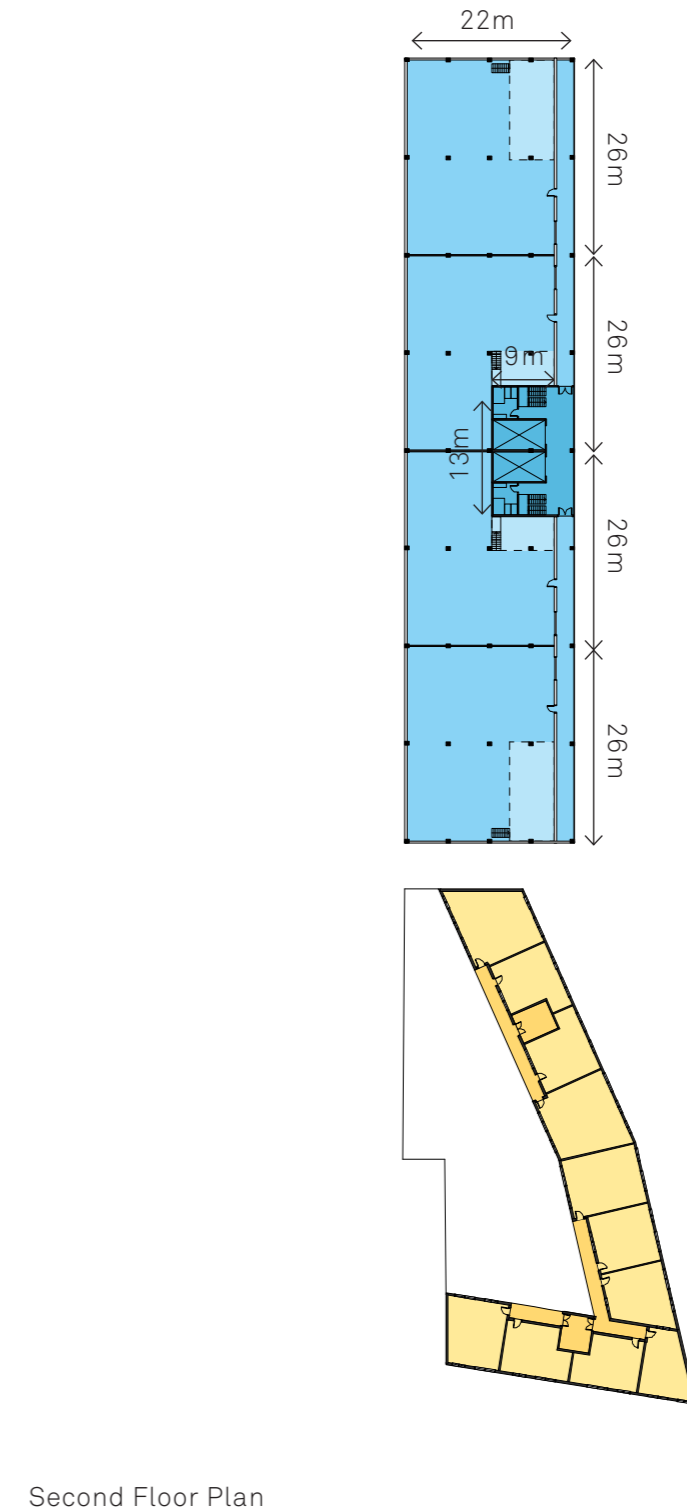
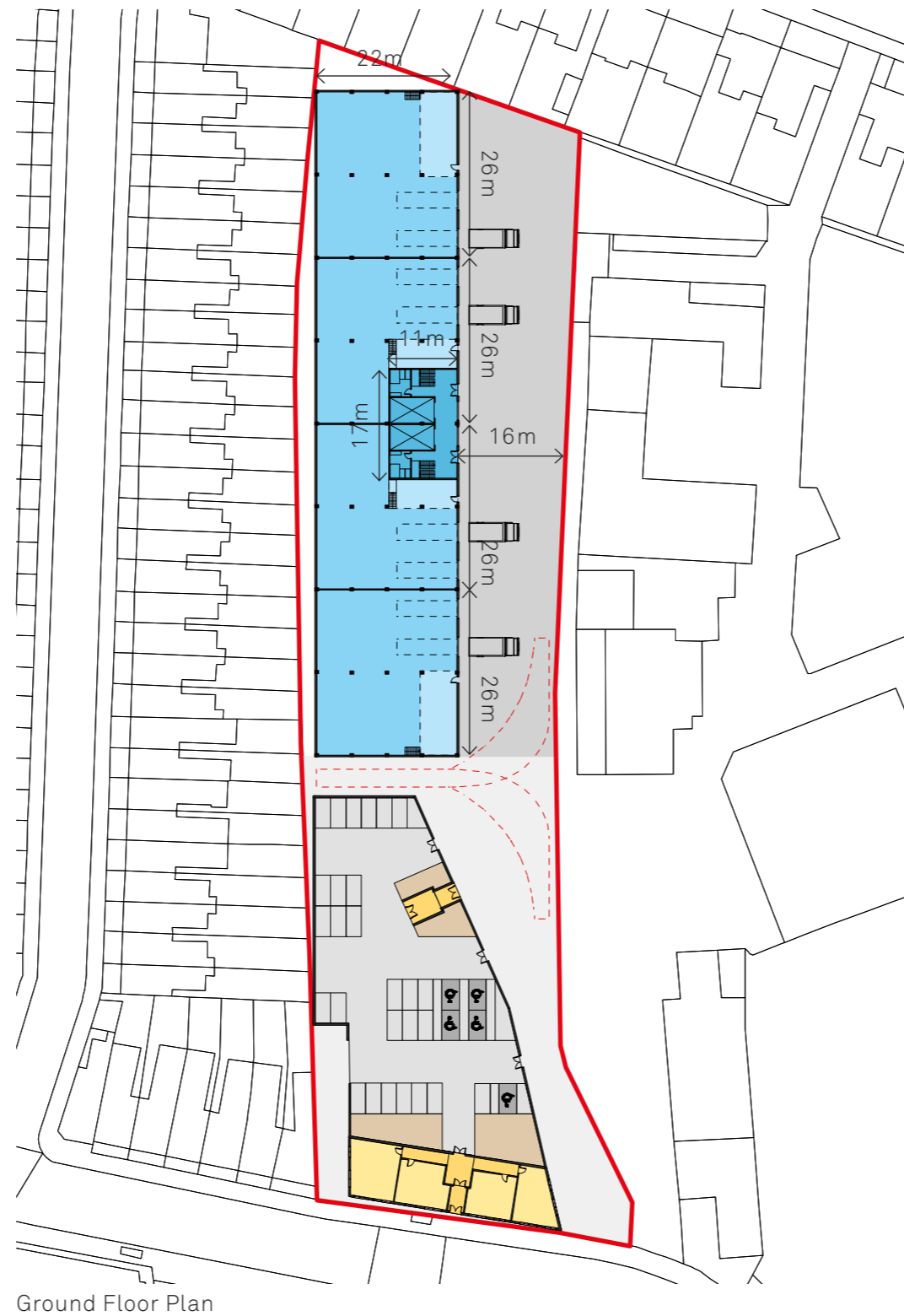

Stacked small industrial with adjacent residential

Facade treatment

A facade treatment of translucent polycarbonate cladding preserves the privacy of surrounding residential areas whilst providing light to the internal workspace.

KEY

1. Translucent polycarbonate cladding
2. Brick masonry wall
3. Concrete lift overrun
4. Staff and visitor unit entrances
5. Staff and visitor entrances to upper floors
6. Glazed roller shutter doors
7. Glazed roller shutter doors to goods lifts
8. Green roof

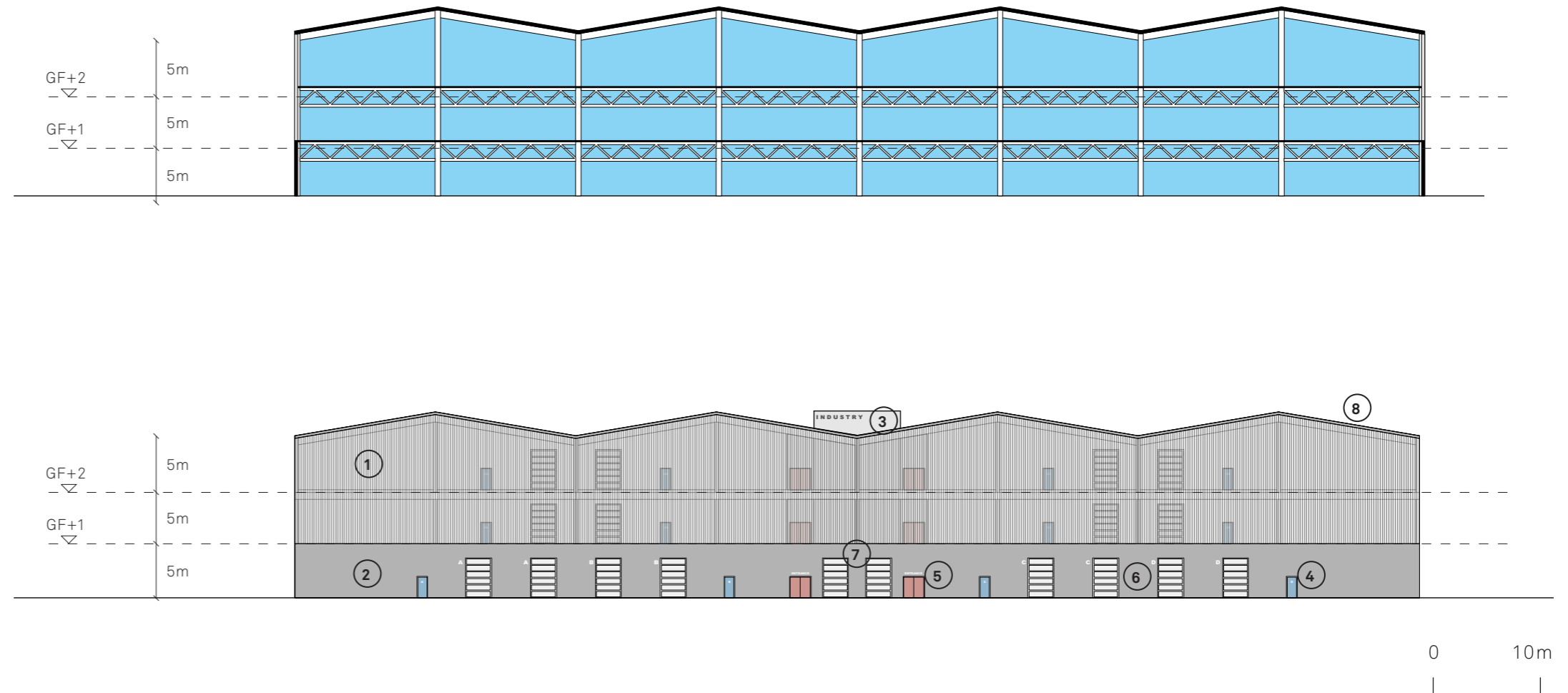

Social Housing, Mulhouse, Lacaton and Vassal



TNG Youth and Community Centre, RCKa



FRAC, Lacaton and Vassal



Vitsø HQ, Vitsø and Martin Francis

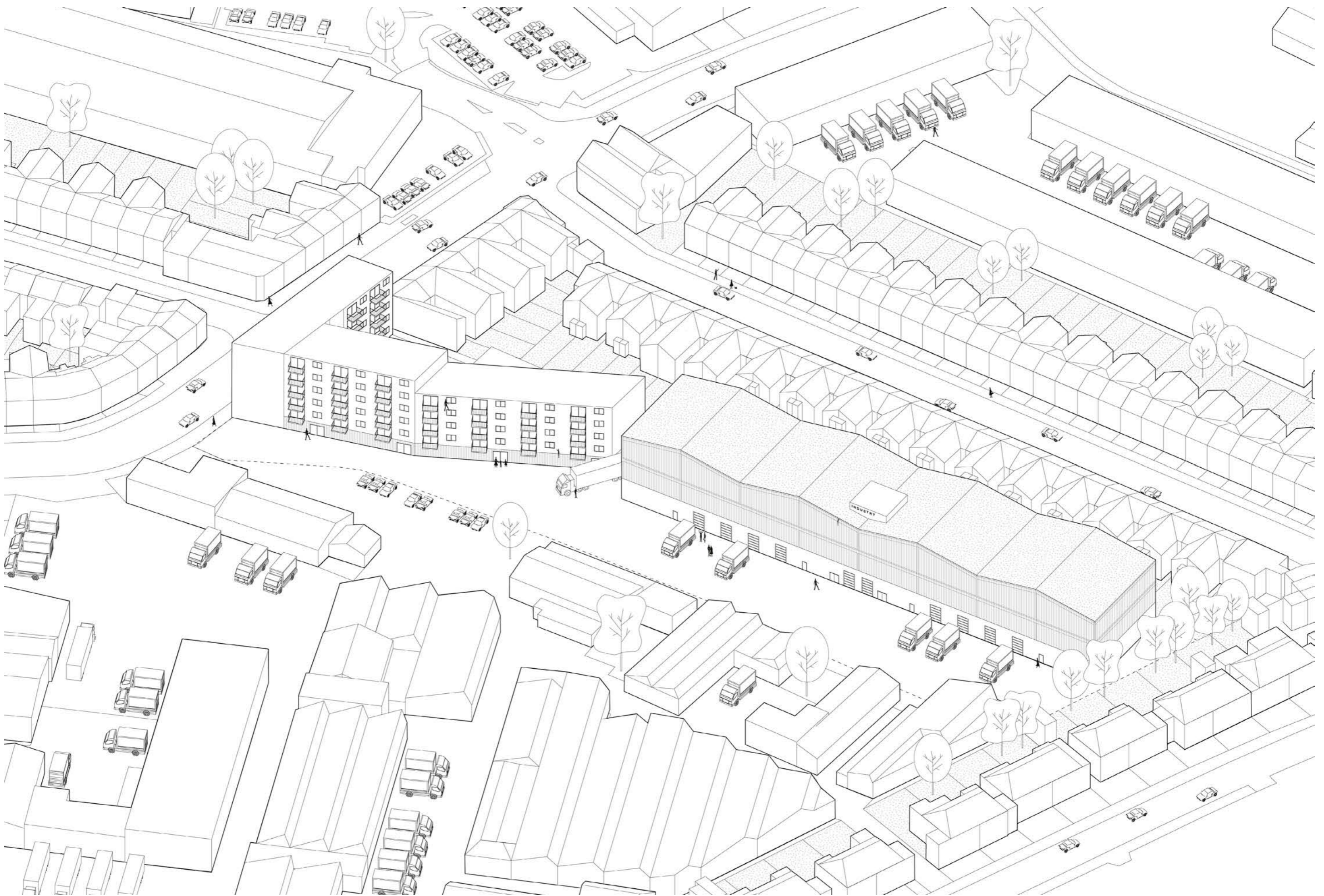

Stacked small industrial with residential

Stacked small industrial with adjacent residential

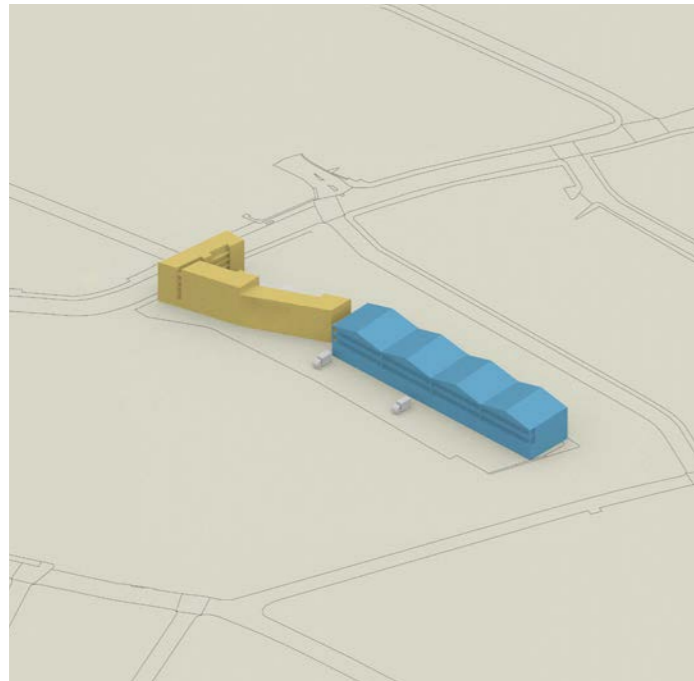

Industrial intensification

Small, narrow sites limit development options due to access requirements

The development of a small, narrow site is most suited to small scale industrial development due to restrictions associated with vehicle access routes and service yards.

Goods lifts can provide efficient access to stacked small industrial units

Goods lifts can provide efficient access to upper level floorspace, maximising stacking and site efficiency. It is recommended that occupiers have access to multiple goods lifts or even private goods lifts to ensure reliability. As upper level units are currently uncommon, occupiers may be hesitant to take on this type of space. Two or three levels of stacked provision may therefore be a reasonable limit for shared goods lift.

Small industrial only require LGV yard access and occasional HGV access

Small industrial units only require direct LGV access to service yard and industrial floorspace. HGV access can be limited to a shared loading area on the site due to less frequent demand.

Separation of routes is challenging on a narrow site with access from only one short side

Separation of LGV/HGV, vehicle and pedestrian access into site is difficult on a small, narrow site with access only from one short side.

High upper level floor loadings allow greater range of potential occupiers but result in significant structural requirements that constrain internal clear spans and impact build costs

High upper level floor loadings allow potential for both industrial and logistics occupiers. These result in structural depths of approximately 2m, significantly reducing internal clear spans, potentially limiting flexibility for occupiers.

Residential co-location

Opportunity for residential development providing positive street frontage along main road

Stacked small industrial allows for residential development at the front of the site, providing positive street frontage along the main road.

Industrial provision can provide an opportunity for acoustic and other environmental mitigation between service yards and surrounding residential areas

Locating industrial provision between service yards and surrounding residential areas ensures mitigation between new industrial provision and existing residential use.

Ground floor podium car park can act as a buffer between residential development and industrial circulation whilst providing shared amenity space

A ground floor car park can provide a buffer between HGV/LGV circulation to industrial provision at the back of the site, past the residential at the front. This can also provide podium level amenity space for residential development.

Lower build costs are associated with adjacent residential and industrial development

Build costs are lower for separate residential and industrial developments due to reduced mitigation measures and structural and facade requirements.

Additional design factors

Significant green roofs are required to meet urban greening requirements

An urban greening factor of 0.3 for industrial uses (as outlined in Draft London Plan 2017) can be achieved by assuming an extensive green roof with a minimum settled depth 80mm for substrate factor 0.7. Other urban greening measures might be feasible such as green walls, permeable paving and tree planting in open areas which are not required for operational yard space.

Green roofs can provide amenity space for residential units

Green roofs required to meet urban greening requirements can provide amenity space for residential units whilst offering an improved visual outlook above ground floor medium industrial unit.

6.0

VIABILITY RESULTS

6.1 Introduction

The method for testing scheme viability in this study is based on the same approach in the London Plan Viability Study (LPVS) which is the document published as part of the evidence base for the draft London Plan (2017). Most of the viability assumptions in this study are also taken from the LPVS. The instances in which there are divergences between the assumptions in this study and the LPVS are set out below.

This study uses the ARGUS Developer appraisal package which is an industry standard for viability testing.

6.2 Methodology

The method used for testing the viability of the different schemes in this study (and in the LPVS) is based on comparing the residual land value (RLV) from a development appraisal of a proposed scheme against a threshold value. The threshold this study uses is benchmark land values (BLVs). The BLV is an estimate of the existing use value of the test sites based on dividing estimated achievable rents for total floorspace by yields plus a premium. The GLA suggests a landowner's premium of 20%. This provides an incentive above EUV for the landowner to sell or bring forward a site for development. Leasehold buy out costs are not explicitly allowed for in this assumption and could significantly increase the cost of bringing the site forward. The appropriateness of just using BLV as an indication of up-front costs will depend on the characteristics of specific sites.

If the RLV is sufficiently greater than a BLV then the scheme is considered potentially commercially attractive and a landowner is likely to be sufficiently incentivised to release the site for development. If the RLV is roughly equivalent to the BLV then the scheme is marginally viable. If the RLV is less than the BLV then the scheme is commercially unattractive and there is little incentive for the landowner to bring the site forward for redevelopment.

6.3 Scheme appraisals

We assessed four theoretical development schemes of intensified industrial premises on three test sites in different locations across London. Three of the four schemes included a residential element. For each of the schemes with a residential component ten viability appraisals were generated. The appraisals consider different levels of affordable housing (50%, 35%, 20% and 0%) and mixes of affordable housing tenures (London Affordable Rent, London Shared Ownership, London Living Rent and Discounted Market Rent).

The viability appraisals generate an RLV which is equivalent to the sum left over to purchase the land after all scheme development costs (including the developers profit) are subtracted from the gross development value (GDV) of the scheme. The simple equation for calculating the RLV is:

$RLV = GDV - \text{Total development costs (including developers profit)}$

GLOSSARY

CPO	Compulsory Purchase Order
DMR	Discounted Market Rent
EUV	Existing Use Value
GDV	Gross Development Value
LAR	London Affordable Rent
LLR	London Living Rent
LPVS	London Plan Viability Study
LSO	London Shared Ownership
RLV	Residual Land Value

6.4 Assumptions

Key Assumptions which differ from those in the LPVS

Most of the assumptions used the viability appraisals are from the LPVS. We do not summarise the assumptions used in the LPVS here. The following text is about the instances when this study's assumptions diverge with the LPVS.

Value Assumptions (Rents, Sales Values, Yields)

The value assumptions for both the industrial rents and yields and the market rate residential values are from research undertaken by Savills. They are based on discussions with Savills agents, Savills proprietary data and publicly available databases. The data used in this study reflect the particular property sub-market areas where the three sites are located. The LPVS uses a zonal approach across London to establish the value assumptions. The zonal approach is appropriate for high-level testing but the more geographically targeted approach used in this study is appropriate for assessing submarket areas.

Benchmark Land Values (BLVs)

This study calculates three BLV scenarios for each of the three sites. The BLVs are based on the range of rents and yields for industrial buildings in the sub-market areas within which the subject sites are situated. The rents and yields used to establish the BLVs were provided by the GLA. The assumptions for the low and medium BLVs are based on evidence from existing use valuation reports for industrial sites that are coming forward for development. These were provided in support of financial viability assessments for planning applications over the last 12 months. The report also tests a higher BLV based on assumptions provided by the GLA.

Our information on recent deals and market intelligence suggests that the rents assumptions underlying the BLVs provided by the GLA may be significantly below emerging values in Inner London. The assumptions are more reflective of Outer London and/or poorer quality assets. The yields provided by the GLA are conservative estimates compared to currently observed comparable yields in the market.

The GLA applied a 20% mark-up to the value of the existing use value of the land to incentivise landowners to release their land for development in line with benchmark land values applied in viability assessments and local plan assessments. It is possible that the 20% mark-up may be insufficient to incentivise some land owners to sell. If there are longer leases in place and the stock is modern and adaptable for future industrial uses then a premium greater than that assumed in the BLV could be required.

If the assumptions underlying the BLVs were less conservative then the development schemes would be less viable.

The three BLV scenarios reflect the range of potential existing site conditions. A low BLV reflects sites with poor industrial premises. These are sites that are

most likely to come forward for redevelopment. A high BLV reflects sites that currently function well and have good quality accommodation. Such sites are less likely to come forward and there could be additional up-front costs such as leasehold buy-out. The range of different BLVs allow for generalised conclusions to be drawn about which conditions are conducive for sites coming forward for redevelopment.

The LPVS also uses BLVs to compare with RLVs. The BLVs in the LPVS are based on the GLA's analysis of BLVs agreed on a range of sites that have come forward for planning. Through discussions with the GLA it was agreed that a different methodology would be appropriate to set a threshold value because the LPVA's BLVs cover a wider range of uses rather than the industrial sites that are the focus of this study.

Location	Existing Provision (m2)	Existing Provision (ft2)	1. Rent (low BLV)	2. Rent (medium BLV)	3. Rent (high BLV)	1. Yield (low BLV)	2. Yield (medium BLV)	3. Yield (higher BLV)	1. BLV (low)	2. BLV (medium)	3. BLV (high)
Area 1 Inner London	4,892	52,638	£8.50	£13.00	£15.50	7.0%	6.0%	5.5%	£7,670,097	£13,685,859	£17,801,187
Area 2 Suburban London	7,908	85,090	£6.50	£8.50	£10.50	7.0%	6.0%	5.5%	£9,481,466	£14,465,314	£19,493,364
Area 3 Urban London	3,371	36,272	£9.00	£12.50	£15.50	7.0%	6.0%	5.5%	£5,596,245	£9,067,990	£12,266,517

BLV per acre

Location	1. BLV (low)	2. BLV (medium)	3. BLV (high)
Area 1 Inner London	£6,015,696	£10,733,889	£13,961,562
Area 2 Suburban London	£2,177,340	£3,321,839	£4,476,489
Area 3 Urban London	£3,112,207	£5,042,927	£6,821,705

Construction Costs

We use construction costs provided by cost consultant Feasibility. They provided bespoke advice for the development typologies of intensified industrial premises. However the work is still at a broad brush level and it is possible that further work on industrial intensification and/or specific schemes could suggest higher costs than those we have used.

The LPVS used data from the Building Cost Information Service (BCIS). The costs assume a 5% contingency and other allowances as set out in the LPVS. However these may not reflect all site specific abnormal costs. If these costs are more than assumed this would reduce BLVs/increase up-front costs.

BLV Scenarios

For each scenario the GDV, the total development cost, the RLV and the RLV per acre are presented.

The RLV is compared against the three BLV scenarios (low, medium and high). Instances in which the RLV is greater than the BLV are highlighted in green and indicate the reasonable likelihood of viability. Instances where they are roughly equivalent are highlighted in orange and indicate marginal viability. Instances where the RLV is below the BLV are highlighted in red and suggest the scheme is not commercially attractive.

For the three schemes that have a residential component the disaggregation of the respective uses' contribution to the overall RLV is presented. Also a chart presents how RLVs compare to the three respective BLV scenarios.

6.5 Site specific viability results

Overall the schemes show positive viability. Their relationship to BLVs is critical to scheme deliverability.

Model Site 1B (Stacked Workshops/Studio with Residential Above) is relatively viable. It has a high quantum of residential accommodation compared to the scheme associated with Model Site 1A. It also has a high overall site coverage (dense development) and slightly higher rental values.

Model Site 1A (Stacked Medium Industrial with Residential Above) performs marginally less well than Model Site 1B because of the lower quantum of residential accommodation and lower site coverage (less densely developed).

Model Site 2 (Stacked Large Industrial without Residential) is unviable in all cases due to high fixed costs and low rents (given its suburban location).

Model Site 3 (Small Industrial with Residential Adjacent) is most viable due to relatively low assumed BLVs, low build costs and a high quantum of industrial floorspace.

		Low EUV	Medium EUV	High EUV
50% AH	(60% LAR/40% LSO)	Model Site 1A Model Site 1B Model Site 3		
	(30% LAR/35% LLR/35% LSO)	Model Site 1A Model Site 1B Model Site 3	Model Site 3	
	(30% LAR/70% LSO)	Model Site 1A Model Site 1B Model Site 3	Model Site 1A Model Site 3	
	(50% LLR / 50% DMR)	Model Site 1A Model Site 1B Model Site 3	Model Site 1A Model Site 1B Model Site 3	
35% AH	(60% LAR/40% LSO)	Model Site 1A Model Site 1B Model Site 3	Model Site 3	
	(30% LAR/70% LSO)	Model Site 1A Model Site 1B Model Site 3	Model Site 1A Model Site 3	
	(50% LLR / 50% DMR)	Model Site 1A Model Site 1B Model Site 3	Model Site 1A Model Site 1B Model Site 3	
20% AH	(60% LAR/40% LSO)	Model Site 1A Model Site 1B Model Site 3	Model Site 1A Model Site 1B Model Site 3	Model Site 3
	(30% LAR/70% LSO)	Model Site 1A Model Site 1B Model Site 3	Model Site 1A Model Site 1B Model Site 3	
	(50% LLR / 50% DMR)	Model Site 1A Model Site 1B Model Site 3	Model Site 1A Model Site 1B Model Site 3	
0% AH		Model Site 1A Model Site 1B Model Site 3	Model Site 1A Model Site 1B Model Site 3	Model Site 3

Stacked workshops/studios
with residential above

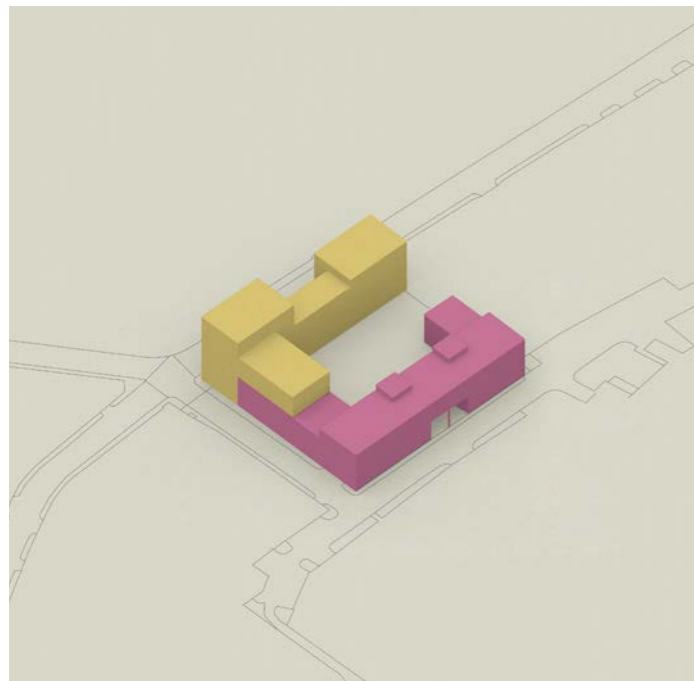

Key scheme parameters

Industrial/ancillary office 6,009 m² GIA
Residential 8,253 m² GIA
(92 units)
Total 14,262 m² GIA

Values

Small industrial units £194 /m²
(£18.00 /ft²)
Yield 4.25%
Residential units (market) £7,532 /m²
(£700 /ft²)
Residential units (AH) £2,380 - £6,152 /m²
£221 - £572 /ft²

Costs

Industrial £1,494 /m²
(£139 /ft²)
Residential £2,690 /m²
(£250 /ft²)

Viability results from scenarios

Scenario	AH Mix	Overall Scheme				RLV-BLV (low)	RLV-BLV (med)	RLV-BLV (high)
		GDV	Total Cost	RLV	RLV per acre	BLV per acre = £6,015,696	BLV per acre = £10,733,889	BLV per acre = £13,961,562
50% AH	(60% LAR/40% LSO)	65,436,248	54,534,123	10,902,125	8,550,686			
	(30% LAR/35% LLR/35% LSO)	66,848,736	54,823,526	12,025,210	9,431,537			
	(30% LAR/70% LSO)	67,815,676	55,098,243	12,717,433	9,974,457			
	(50% LLR / 50% DMR)	68,692,413	53,535,728	15,156,685	11,887,596			
35% AH	(60% LAR/40% LSO)	69,424,840	57,031,431	12,393,409	9,720,321			
	(30% LAR/70% LSO)	71,087,197	57,438,426	13,648,771	10,704,918			
	(50% LLR / 50% DMR)	70,649,313	55,449,514	15,199,799	11,921,411			
20% AH	(60% LAR/40% LSO)	73,431,490	59,361,257	14,070,233	11,035,477			
	(30% LAR/70% LSO)	74,376,200	59,599,544	14,776,656	11,589,534			
	(50% LLR / 50% DMR)	72,614,408	57,327,018	15,287,390	11,990,110			
0% AH		78,757,713	60,944,252	17,813,461	13,971,342			

Industrial and residential contributions to overall RLVs

Scenario	AH Mix	Industrial		Residential	
		GDV	RLV	GDV	RLV
50% AH	(60% LAR/40% LSO)	26,353,756	5,568,826	39,082,492	5,333,299
	(30% LAR/35% LLR/35% LSO)	26,353,756	5,724,338	40,494,980	6,300,872
	(30% LAR/70% LSO)	26,353,756	5,779,903	41,461,920	6,937,530
	(50% LLR / 50% DMR)	26,353,756	6,602,279	42,338,657	8,554,406
35% AH	(60% LAR/40% LSO)	26,353,756	5,196,482	43,071,084	7,196,927
	(30% LAR/70% LSO)	26,353,756	5,311,620	44,733,441	8,337,151
	(50% LLR / 50% DMR)	26,353,756	6,013,911	44,295,557	9,185,888
20% AH	(60% LAR/40% LSO)	26,353,756	4,910,433	47,077,734	9,159,800
	(30% LAR/70% LSO)	26,353,756	4,960,798	48,022,444	9,815,858
	(50% LLR / 50% DMR)	26,353,756	5,491,186	46,260,652	9,796,204
0% AH		26,353,756	4,810,188	52,403,957	13,003,273

Stacked workshops/studios with residential above

The results show that the scheme is commercially attractive in all low BLV scenarios and nearly all of the medium BLV scenarios. The scheme is not attractive in all high BLV scenarios with the exception of the 0% affordable housing scenario.

In the 50% affordable housing scenarios the contribution of the industrial and residential component to the overall RLV is roughly equivalent. As the level of affordable housing is reduced in succeeding scenarios, the residential component contributes a greater share towards the scheme's total RLV.

The medium and high BLVs applied to the site could be considered higher than what one might expect on a typical industrial site because of the high existing site coverage (95%). The amount of existing provision is such that it could be viewed as inflating the BLV value. Most sites that are likely to come forward for redevelopment would be expected to contain a lesser quantum of well performing floorspace. There are though other factors, such as leasehold buy-out costs that could increase up-front costs.

RLV by use and affordable housing level

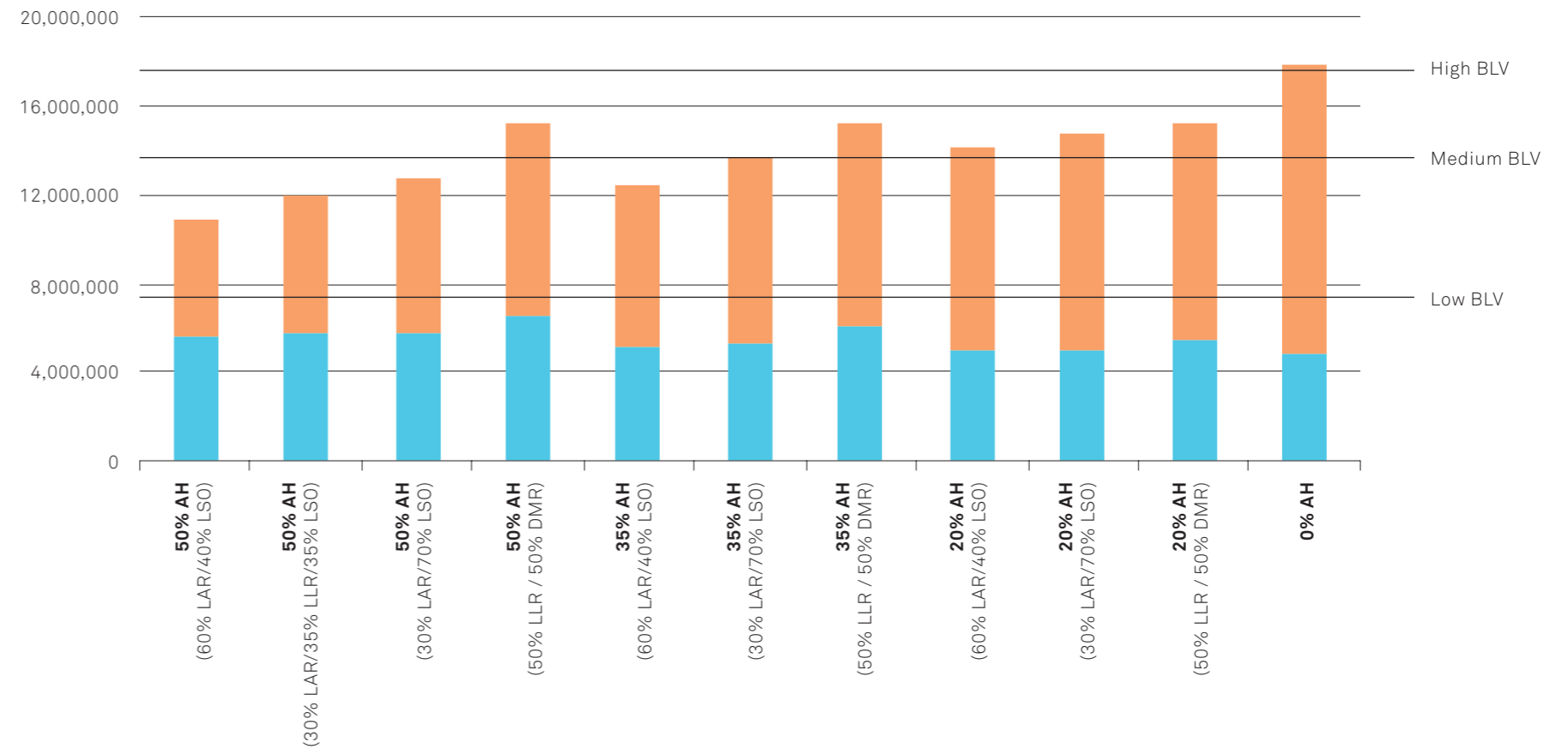

Stacked medium industrial
with residential above

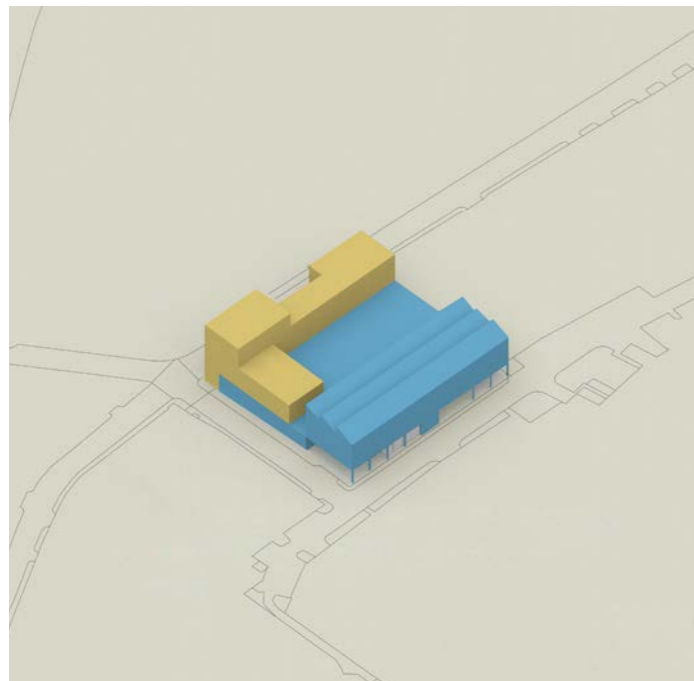

Key scheme parameters

Industrial/ancillary office	6,306 m ² GIA
Residential	6,905 m ² GIA (76 units)
Total	13,211 m² GIA

Values

Small/medium industrial units	£188 /m ² (£17.50 /ft ²) Yield 4.25%
Residential units (market)	£7,532 /m ² (£700 /ft ²)
Residential units (AH)	£2,380 - £6,152 /m ² (£221 - £572 /ft ²)

Costs

Industrial	£1,210 /m ² (£110 /ft ²)
Residential	£2,690 /m ² (£250 /ft ²)

Viability results from scenarios

Scenario	AH Mix	Overall Scheme				RLV-BLV (low)	RLV-BLV (med)	RLV-BLV (high)
		GDV	Total Cost	RLV	RLV per acre	BLV per acre = £6,015,696	BLV per acre = £10,733,889	BLV per acre = £13,961,562
50% AH	(60% LAR/40% LSO)	59,564,915	47,690,037	11,874,878	9,313,630			
	(30% LAR/35% LLR/35% LSO)	60,740,323	47,673,911	13,066,412	10,248,166			
	(30% LAR/70% LSO)	61,501,219	48,061,889	13,439,330	10,540,651			
	(50% LLR / 50% DMR)	62,301,055	46,801,150	15,499,905	12,156,788			
35% AH	(60% LAR/40% LSO)	62,912,529	49,823,051	13,089,478	10,266,257			
	(30% LAR/70% LSO)	64,308,328	50,164,390	14,143,938	11,093,285			
	(50% LLR / 50% DMR)	63,935,993	48,415,721	15,520,272	12,172,762			
20% AH	(60% LAR/40% LSO)	66,251,357	51,996,181	14,255,176	11,180,530			
	(30% LAR/70% LSO)	67,045,247	52,197,746	14,847,501	11,645,099			
	(50% LLR / 50% DMR)	65,607,932	50,061,461	15,546,471	12,193,311			
0% AH		70,719,552	54,095,813	16,623,739	13,038,227			

Industrial and residential contributions to overall RLVs

Scenario	AH Mix	Industrial		Residential	
		GDV	RLV	GDV	RLV
50% AH	(60% LAR/40% LSO)	26,887,709	7,498,463	32,677,206	4,376,415
	(30% LAR/35% LLR/35% LSO)	26,887,709	7,774,384	33,852,614	5,292,028
	(30% LAR/70% LSO)	26,887,709	7,729,626	34,613,510	5,709,704
	(50% LLR / 50% DMR)	26,887,709	8,613,664	35,413,346	6,886,241
35% AH	(60% LAR/40% LSO)	26,887,709	7,085,803	36,024,820	6,003,675
	(30% LAR/70% LSO)	26,887,709	7,198,602	37,420,619	6,945,336
	(50% LLR / 50% DMR)	26,887,709	8,030,864	37,048,284	7,489,408
20% AH	(60% LAR/40% LSO)	26,887,709	6,677,254	39,363,648	7,577,922
	(30% LAR/70% LSO)	26,887,709	6,731,451	40,157,538	8,116,050
	(50% LLR / 50% DMR)	26,887,709	7,479,450	38,720,223	8,067,021
0% AH		26,887,709	6,481,495	43,831,843	10,142,244

Stacked medium industrial with residential above

The results for this scheme show broadly the same commercial attractiveness as the Stacked Workshop/Studio with Residential format but there are some key differences.

The scheme is commercially attractive in all low BLV scenarios and nearly all medium BLV scenarios. The scheme is unattractive in all high BLV scenarios.

The scheme's industrial element contributes more towards the overall RLV (compared to the residential) because of the larger quantum of floorspace compared to Stacked Workshop/Studio with Residential format. However the overall viability is slightly worse. There are two reasons for this. The first is that Stacked Workshop/Studio with Residential format has slightly higher rents per square foot. The other reason is that it contains 92 residential units compared to 76 for Stacked Medium Industrial with Residential scheme. The additional 16 units in the Stacked Workshop/Studio with Residential scheme creates greater value.

RLV by use and affordable housing level

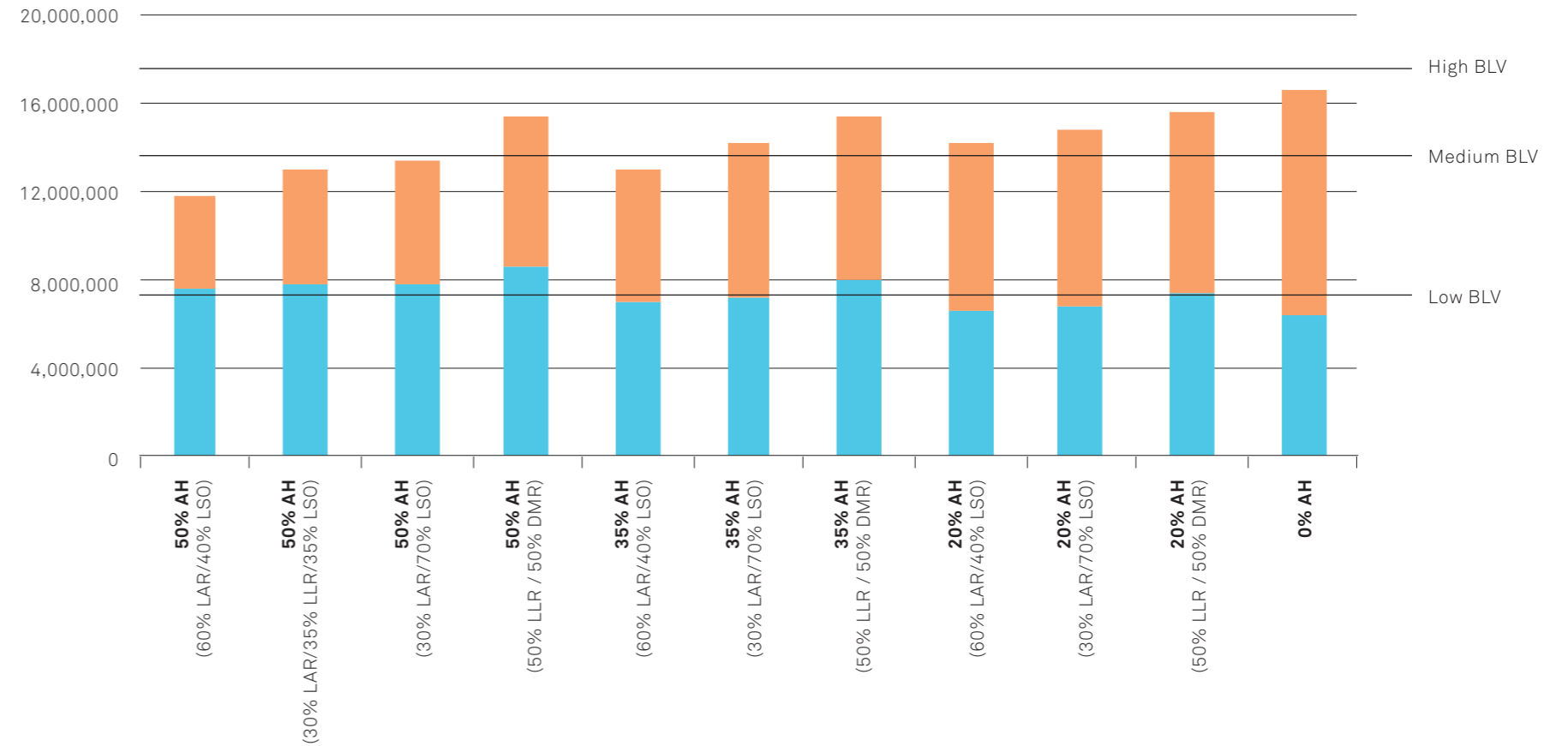

Stacked large industrial

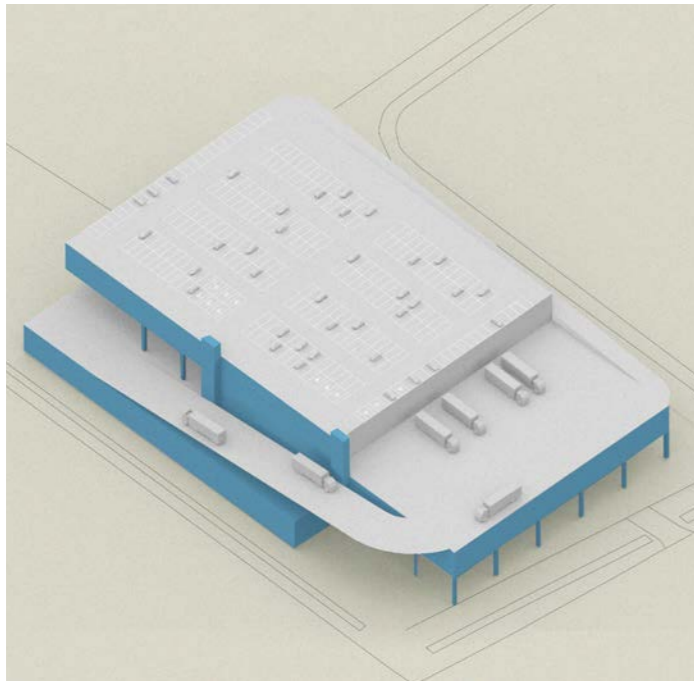

Viability results

GDV	Total Cost	RLV	RLV-BLV (low) BLV per acre = £6,015,696	RLV-BLV (med) BLV per acre = £10,733,889	RLV-BLV (high) BLV per acre = £13,961,562
62,830,016	76,184,016	-13,354,000			

Key scheme parameters

Industrial/ancillary office 28,163 m² GIA

Values

Large industrial units £105 /m²
(£9.75 /ft²)
Yield 4.25%

Cost

£2,052 /m²
£182 /ft²

Stacked large industrial

The results of viability testing show that in all BLV scenarios the scheme is commercially unattractive. The achievable rental level in this location does not generate sufficient value for the scheme to be viable. Stacked large industrial premises is particularly expensive to build due for example to the ramps that convey lorries to the upper storeys. The scheme is constrained because it does not enable the scheme to achieve economies of scale that could dilute fixed costs such as the ramps. A greater quantum of rentable floorspace could achieve a higher return whilst reducing the average build cost per square metre, which larger sites could facilitate. Another factor that is limiting the viability is the rental levels. To ensure that a stacked large industrial scheme is viable the rental levels need to be significantly higher than the level that can be achieved in Model Site 2. Larger sites with a greater quantum of floorspace and locations where rental levels are higher would contribute towards improving the viability of such a scheme.

Stacked small industrial
with adjacent residential

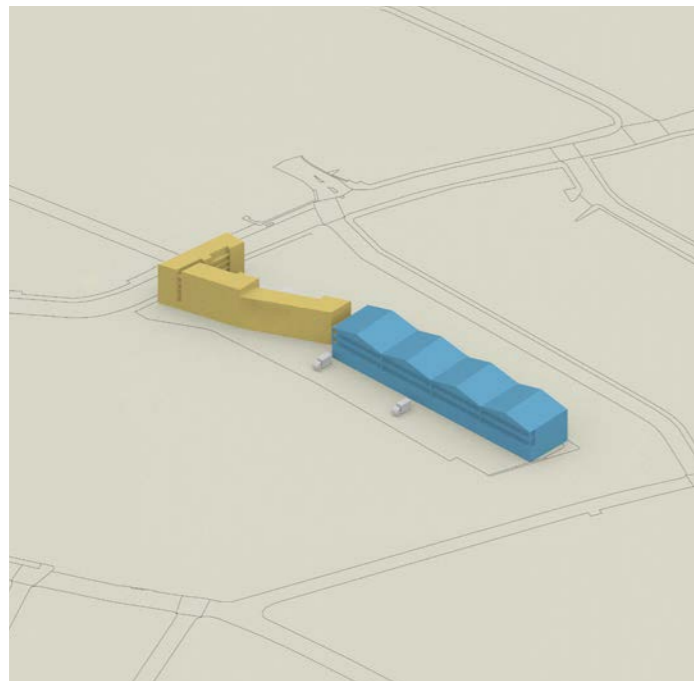

Key scheme parameters

Industrial/Ancillary Office 7,787 m² GIA
Residential 5,085 m² GIA
(55 units)
Total 12,872 m² GIA

Values

Small/medium industrial units £172 /m²
(£16.00 /ft²)
Yield 4.50%
Residential units (market) £7,532 /m²
(£700 /ft²)
Residential units (AH) £2,380 - £6,152 /m²
(£221 - £572 /ft²)

Costs

Industrial £1,193 /m²
(£111 /ft²)
Residential £2,690.00 /m²
(£250 /ft²)

Viability results from scenarios

Scenario	AH Mix	Overall Scheme				RLV-BLV (low)	RLV-BLV (med)	RLV-BLV (high)
		GDV	Total Cost	RLV	RLV per acre	BLV per acre = £3,112,207	BLV per acre = £5,042,927	BLV per acre = £6,821,705
50% AH	(60% LAR/40% LSO)	52,639,359	44,357,024	8,282,335	4,606,415			
	(30% LAR/35% LLR/35% LSO)	53,500,097	43,538,332	9,961,765	5,540,470			
	(30% LAR/70% LSO)	54,126,671	43,911,420	10,215,251	5,681,452			
	(50% LLR / 50% DMR)	54,674,733	42,703,757	11,970,976	6,657,940			
35% AH	(60% LAR/40% LSO)	55,105,725	45,179,368	9,926,357	5,520,777			
	(30% LAR/70% LSO)	56,129,114	45,427,398	10,701,716	5,952,011			
	(50% LLR / 50% DMR)	55,895,111	44,395,223	11,499,888	6,395,933			
20% AH	(60% LAR/40% LSO)	57,589,963	45,563,930	12,026,033	6,688,561			
	(30% LAR/70% LSO)	58,165,138	47,022,738	11,142,400	6,197,108			
	(50% LLR / 50% DMR)	57,111,747	45,288,428	11,823,319	6,575,817			
0% AH		60,872,171	48,531,848	12,340,323	6,863,361			

Industrial and residential contributions to overall RLVs

Scenario	AH Mix	Industrial		Residential	
		GDV	RLV	GDV	RLV
50% AH	(60% LAR/40% LSO)	28,605,529	6,733,099	24,033,830	1,549,236
	(30% LAR/35% LLR/35% LSO)	28,605,529	7,708,854	24,894,568	2,252,911
	(30% LAR/70% LSO)	28,605,529	7,665,195	25,521,142	2,550,056
	(50% LLR / 50% DMR)	28,605,529	8,762,427	26,069,204	3,208,549
35% AH	(60% LAR/40% LSO)	28,605,529	7,118,107	26,500,196	2,808,250
	(30% LAR/70% LSO)	28,605,529	7,264,072	27,523,585	3,437,644
	(50% LLR / 50% DMR)	28,605,529	7,919,554	27,289,582	3,580,334
20% AH	(60% LAR/40% LSO)	28,605,529	7,656,317	28,984,434	4,369,716
	(30% LAR/70% LSO)	28,605,529	6,861,166	29,559,609	4,281,234
	(50% LLR / 50% DMR)	28,605,529	7,701,127	28,506,218	4,122,192
0% AH		28,605,529	6,714,166	32,266,642	5,626,157

Stacked small industrial with adjacent residential

The results show this to be the most viable scheme. Contributing to its viability is the relatively larger quantum of industrial floorspace and lower build costs.

The viability tests show that the scheme is mostly commercially attractive in the low and medium BLV scenarios. This is consistent with the other schemes with a residential element. It is also either attractive or marginally attractive in the high BLV scenario.

The reason for the good viability results for the Stacked Small/Medium Industrial with Adjacent Residential scheme in the high BLV scenario is that the threshold land value is still relatively low when compared to the high EUV scenario for the other schemes. This is due to the differences in the existing provision on the different sites. The Stacked Workshop/Studio with Residential and Stacked Medium Industrial with Residential schemes were tested on Model Site 1 which has a site coverage of 95%. The site coverage for the Stacked Small/Medium Industrial with Adjacent Residential scheme at Model Site 3 is less than half (46%). In addition the highest achievable rents at the Model Site 3 are still below those in the Model Site 1 sub-market. This highlights the importance of the values of the existing on site uses in determining the extent to which existing industrial premises come forward for redevelopment.

RLV by use and affordable housing level

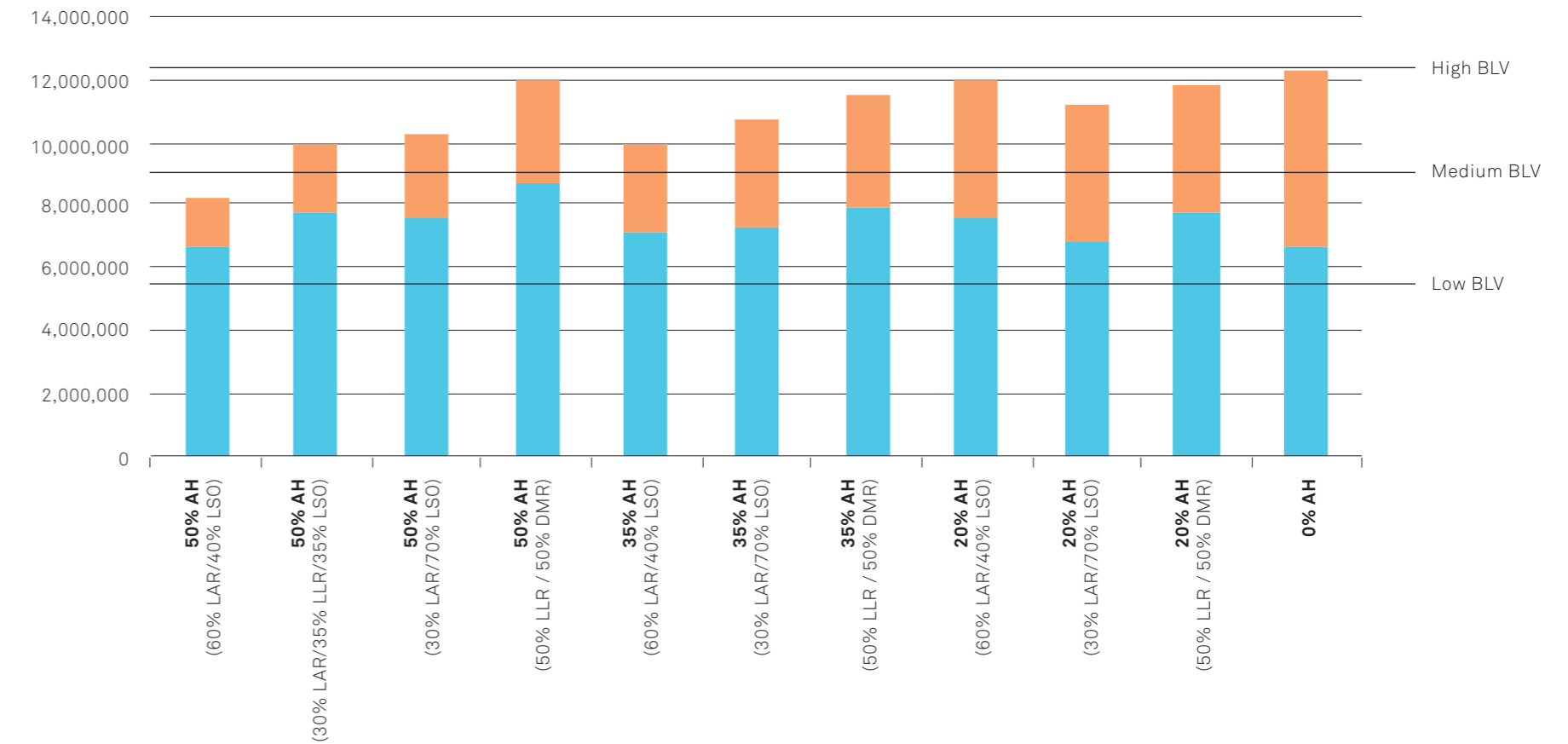

6.6 Generalised viability results

A generalised viability framework for London

The study uses the appraisal and viability results from the four specified schemes to conduct high level sensitivity analysis. The sensitivity analysis provides the framework to consider the viability of different development opportunities across London. The sensitivity analysis takes the appraisals from the specified schemes and applies different levels of industrial rental levels (£10.00 psf, £17.50 psf and £25 psf) and residential sales values (£550 psf, £700 psf and £850 psf) which are broadly representative of the range of rents and sales values that can be found across Greater London.

The appraisals use the different combinations of rents and yields to generate a set of RLVs. The RLVs have been normalised to a per acre basis. The normalisation of RLVs on a per acre basis is useful because acres is the basis typically used to measure land values. Generic per acre BLVs including premiums (£2.5m per acre, £5.0m per acre and £10.0 per acre) are compared with the RLVs to determine likelihood of a scheme coming forward under different value and RLV scenarios.

The BLVs include the GLA's landowner premium of 20% to incentivise landowners to release their land for development which is added to the site specific EUVs. A land owner premium in excess of that assumed in the BLV may be needed in some scenarios. In addition the BLVs do not include leasehold buy out costs which would require a mark-up in excess to the BLV. This combined with strong rentals and yields mean that the high BLV of £10m/acre may not reflect the full costs of acquiring and preparing some sites for development. The range of high, medium and low BLVs is more representative of sites likely to come forward for development rather than all industrial sites.

The results from this sensitivity analysis differ from the analysis of the specified schemes. The results of the sensitivity analysis are independent of the site-specific BLV scenarios used when testing the four site-specific schemes. It enables a more generalised assessment of the economic viability of the different intensified industrial typologies outside of their site-specific context. The results enable a comparison of

the viability of the different typologies of intensified industrial premises under similar conditions.



Sensitivity analysis

The sensitivity analysis assesses the viability of the fully specified schemes using rents and sales values reflective of alternative locations in Greater London. The sensitivity analysis is set out in the table. The fully specified schemes are in colour and were covered in the preceding slides. Whilst the fully specified stacked large industrial scheme for example has been tested in a suburban location (Model Site 2), we have applied a range of rental values reflective of a range of rental values for an Inner London location (e.g. Model Site 1) to an Urban London location (e.g. Model Site 3).

The sensitivity analysis on the following slides is generalised to reflect a range of development contexts in Greater London.

The tables below shows the viability results of one of the schemes which was developed for Model Site 1. It shows the viability results based on different levels of affordable housing, industrial values, residential sales values and BLV scenarios.

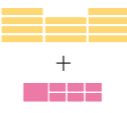
The results are presented on a per acre basis to enable comparisons and generalisations with other typologies or with actual available sites.

	Area 1: Inner London	Area 2: Suburban London	Area 3: Urban London
A. Stacked large industrial	 Scheme appraisal with generic build costs	 Design tested and detailed appraisal	 Scheme appraisal with generic build costs
B. Stacked medium industrial with residential	 Design tested and detailed appraisal	 Scheme appraisal with generic build costs	 Scheme appraisal with generic build costs
C. Stacked workshop / studio with residential	 Design tested and detailed appraisal	 Scheme appraisal with generic build costs	 Scheme appraisal with generic build costs
D. Stacked medium industrial with residential	 Scheme appraisal with generic build costs	 Scheme appraisal with generic build costs	 Design tested and detailed appraisal

Stacked medium industrial with residential above

The tables below shows the viability results of one of the schemes which was developed for Area 1 Inner London – Model Site 1A (stacked medium industrial with residential above). It shows the viability results based on different levels of affordable housing, industrial values, residential sales values and BLV scenarios.

The results are presented on a per acre basis to enable comparisons and generalisations with other typologies or with actual available sites.

RLV per acre and viability as per low, medium and high BLV

BLV = £2.5m

20% AH: 30% LAR / 70% LSO

		Industrial rents per square foot		
		£10.00	£17.50	£25.00
Residential values per square foot	£550	£2.1	£7.3	£12.6
	£700	£6.4	£11.7	£16.9
	£850	£10.7	£16.0	£21.2

35% AH: 30% LAR / 70% LSO

		Industrial rents per square foot		
		£10.00	£17.50	£25.00
Residential values per square foot	£550	£1.8	£7.1	£12.4
	£700	£5.8	£11.1	£16.4
	£850	£9.8	£15.1	£20.4

50% AH: 30% LAR / 70% LSO

		Industrial rents per square foot		
		£10.00	£17.50	£25.00
Residential values per square foot	£550	£1.5	£6.8	£12.2
	£700	£5.2	£10.5	£15.9
	£850	£8.9	£14.3	£19.6

BLV = £5.0m

20% AH: 30% LAR / 70% LSO

		Industrial rents per square foot		
		£10.00	£17.50	£25.00
Residential values per square foot	£550	£2.1	£7.3	£12.6
	£700	£6.4	£11.7	£16.9
	£850	£10.7	£16.0	£21.2

35% AH: 30% LAR / 70% LSO

		Industrial rents per square foot		
		£10.00	£17.50	£25.00
Residential values per square foot	£550	£1.8	£7.1	£12.4
	£700	£5.8	£11.1	£16.4
	£850	£9.8	£15.1	£20.4

50% AH: 30% LAR / 70% LSO

		Industrial rents per square foot		
		£10.00	£17.50	£25.00
Residential values per square foot	£550	£1.5	£6.8	£12.2
	£700	£5.2	£10.5	£15.9
	£850	£8.9	£14.3	£19.6

BLV = £10.0m

20% AH: 30% LAR / 70% LSO

		Industrial rents per square foot		
		£10.00	£17.50	£25.00
Residential values per square foot	£550	£2.1	£7.3	£12.6
	£700	£6.4	£11.7	£16.9
	£850	£10.7	£16.0	£21.2

35% AH: 30% LAR / 70% LSO

		Industrial rents per square foot		
		£10.00	£17.50	£25.00
Residential values per square foot	£550	£1.8	£7.1	£12.4
	£700	£5.8	£11.1	£16.4
	£850	£9.8	£15.1	£20.4

50% AH: 30% LAR / 70% LSO

		Industrial rents per square foot		
		£10.00	£17.50	£25.00
Residential values per square foot	£550	£1.5	£6.8	£12.2
	£700	£5.2	£10.5	£15.9
	£850	£8.9	£14.3	£19.6

Stacked medium industrial with residential above

The figures give a graphic illustration of some of the data in the tables on the preceding slide. It shows the residual land value per acre based on the range of value inputs, AH levels and BLVs. The dashed lines reflect different BLVs (£2.5m, £5.0m and £10.0m per acre).

RV per acre arising from resi values and AH

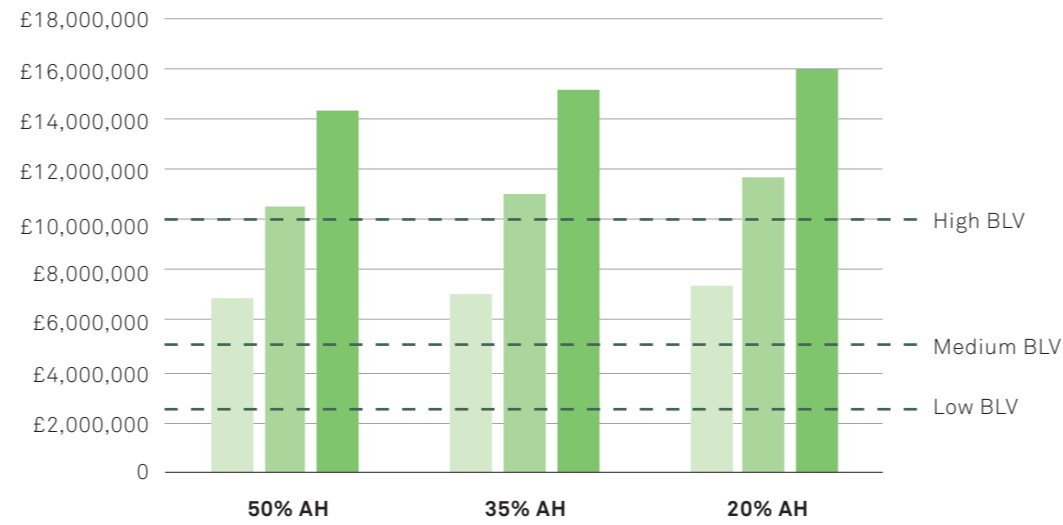

The above figure assumes industrial rents are £17.50/sq.ft

KEY

- £550/sqft
- £700/sqft
- £860/sqft

RV per acre arising from industrial rents and AH

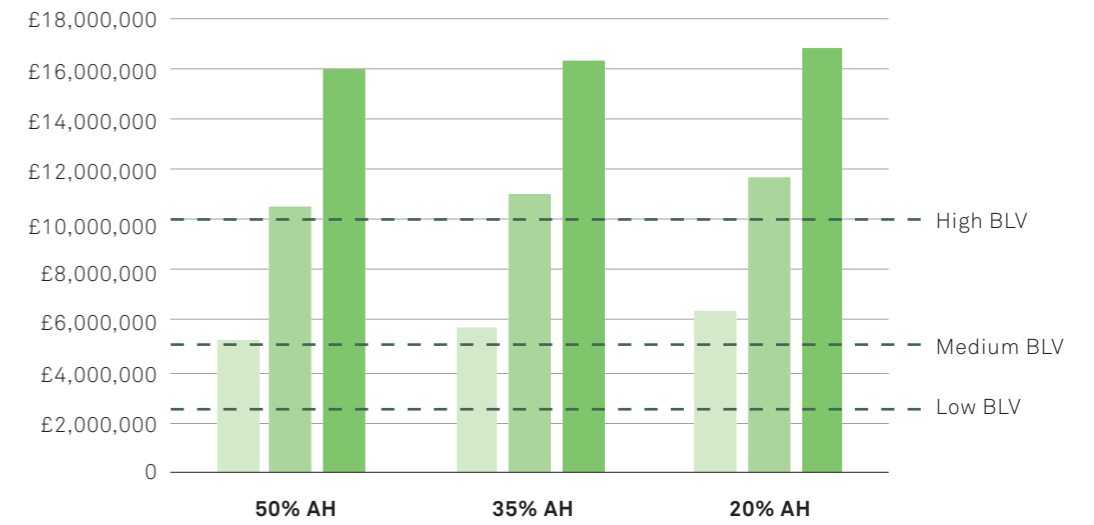

The above figure assumes industrial rents are £17.50/sq.ft

KEY

- £10.00/sqft
- £17.50/sqft
- £25.00/sqft

Stacked workshops/studios with residential above

The tables below shows the viability results of one of the schemes which was developed for Area 1 Inner London – Model Site 1B (stacked workshops/studios with residential above). It shows the viability results based on different levels of affordable housing, industrial values, residential sales values and BLV scenarios.

The results are presented on a per acre basis to enable comparisons and generalisations with other typologies or with actual available sites.

RLV per acre and viability as per low, medium and high BLV

BLV = £2.5m

20% AH: 30% LAR / 70% LSO

		Industrial rents per square foot		
		£10.00	£17.50	£25.00
Residential values per square foot	£550	£1.1	£6.1	£11.1
	£700	£6.3	£11.3	£16.2
	£850	£11.4	£16.4	£21.4

35% AH: 30% LAR / 70% LSO

		Industrial rents per square foot		
		£10.00	£17.50	£25.00
Residential values per square foot	£550	£0.5	£5.6	£10.6
	£700	£5.3	£10.4	£15.4
	£850	£10.1	£15.2	£20.2

50% AH: 30% LAR / 70% LSO

		Industrial rents per square foot		
		£10.00	£17.50	£25.00
Residential values per square foot	£550	£0.1	£5.2	£10.3
	£700	£4.5	£9.6	£14.8
	£850	£9.0	£14.1	£19.2

BLV = £5.0m

20% AH: 30% LAR / 70% LSO

		Industrial rents per square foot		
		£10.00	£17.50	£25.00
Residential values per square foot	£550	£1.1	£6.1	£11.1
	£700	£6.3	£11.3	£16.2
	£850	£11.4	£16.4	£21.4

35% AH: 30% LAR / 70% LSO

		Industrial rents per square foot		
		£10.00	£17.50	£25.00
Residential values per square foot	£550	£0.5	£5.6	£10.6
	£700	£5.3	£10.4	£15.4
	£850	£10.1	£15.2	£20.2

50% AH: 30% LAR / 70% LSO

		Industrial rents per square foot		
		£10.00	£17.50	£25.00
Residential values per square foot	£550	£0.1	£5.2	£10.3
	£700	£4.5	£9.6	£14.8
	£850	£9.0	£14.1	£19.2

BLV = £10.0m

20% AH: 30% LAR / 70% LSO

		Industrial rents per square foot		
		£10.00	£17.50	£25.00
Residential values per square foot	£550	£1.1	£6.1	£11.1
	£700	£6.3	£11.3	£16.2
	£850	£11.4	£16.4	£21.4

35% AH: 30% LAR / 70% LSO

		Industrial rents per square foot		
		£10.00	£17.50	£25.00
Residential values per square foot	£550	£0.5	£5.6	£10.6
	£700	£5.3	£10.4	£15.4
	£850	£10.1	£15.2	£20.2

50% AH: 30% LAR / 70% LSO

		Industrial rents per square foot		
		£10.00	£17.50	£25.00
Residential values per square foot	£550	£0.1	£5.2	£10.3
	£700	£4.5	£9.6	£14.8
	£850	£9.0	£14.1	£19.2

Stacked workshops/studios
with residential above

The figures below give a graphic illustration of some of the data in the tables on the preceding slide. It shows the residual land value per acre based on the range of value inputs, AH levels and BLVs.

The dashed lines reflect different BLVs on a per acre basis.

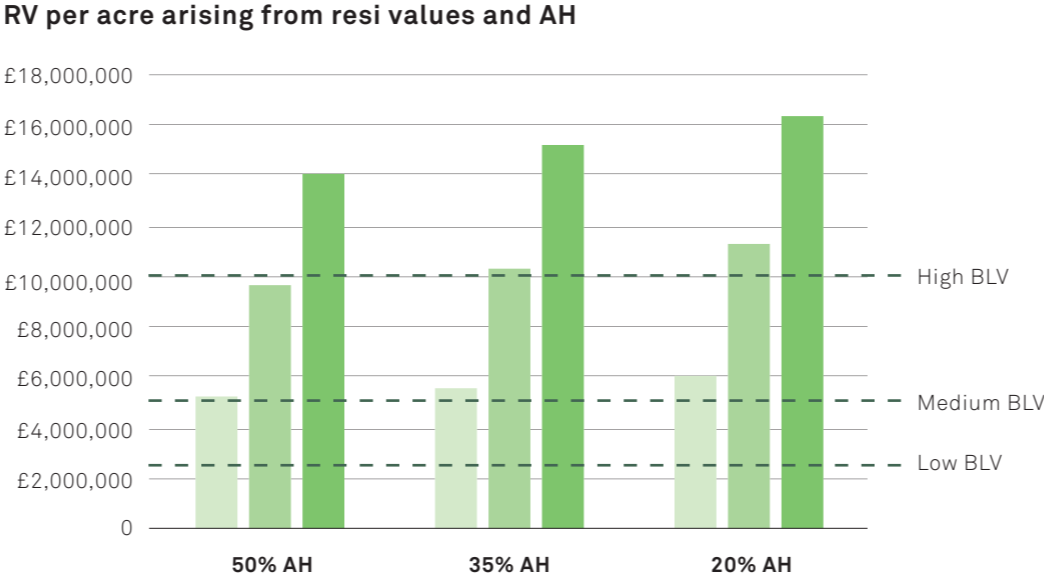

The above figure assumes industrial rents are £17.50/sq.ft

KEY
 £550/sqft
 £700/sqft
 £860/sqft

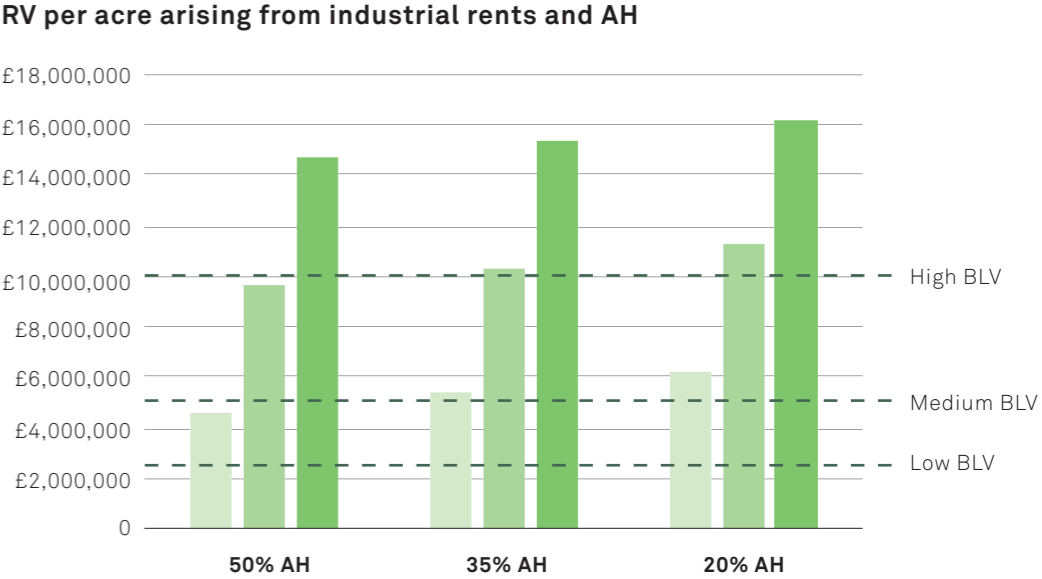

The above figure assumes residential values are £700/sq.ft

KEY
 £10.00/sqft
 £17.50/sqft
 £25.00/sqft

Stacked large industrial

The table shows the viability results of the scheme which was developed for Area 2 Suburban London – Model Site 2 (stacked large industrial). It shows the viability results based on different levels of industrial values and BLV scenarios.

The results are presented on a per acre basis to enable comparisons and generalisations with other typologies or with actual available sites.

The figure gives a graphic illustration of part of the table.

RV per acre

	Industrial rents per square foot		
	£10.00	£17.50	£25.00
Low BLV = £2.5m	-£4.8	£1.7	£7.7
Medium BLV = £5.0m	-£4.8	£1.7	£7.7
High EUV = £10.0m	-£4.8	£1.7	£7.7

RV per acre arising from industrial rents

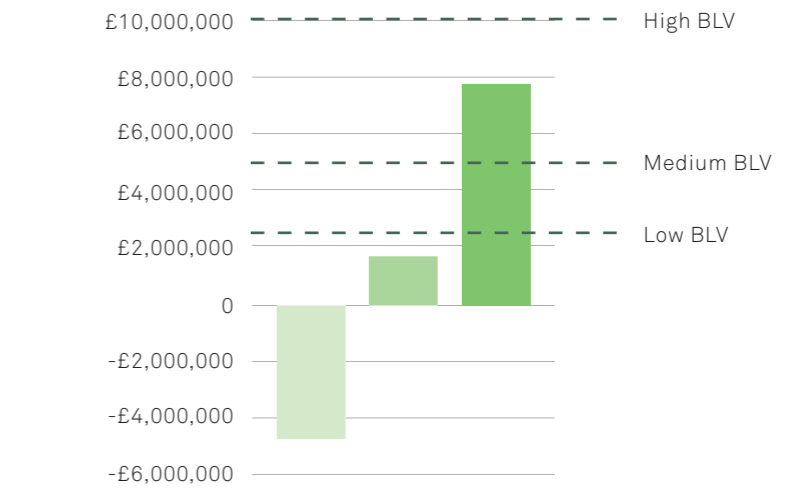

KEY

- £10.00/sqft
- £17.50/sqft
- £25.00/sqft

Stacked small industrial with adjacent residential

The tables below shows the viability results of one of the schemes which was developed for Area 3 Urban London – Model Site 3 (stacked small industrial with adjacent residential). It shows the viability results based on different levels of affordable housing, industrial values, residential sales values and BLV scenarios.

The results are presented on a per acre basis to enable comparisons and generalisations with other typologies or with actual available sites.

RLV per acre and viability as per low, medium and high BLV

BLV = £2.5m

20% AH: 30% LAR / 70% LSO

		Industrial rents per square foot		
		£10.00	£17.50	£25.00
Residential values per square foot	£550	£0.5	£4.8	£9.1
	£700	£2.8	£7.1	£11.4
	£850	£5.0	£9.3	£13.6

35% AH: 30% LAR / 70% LSO

		Industrial rents per square foot		
		£10.00	£17.50	£25.00
Residential values per square foot	£550	£0.4	£4.7	£9.1
	£700	£2.5	£6.8	£11.2
	£850	£4.6	£8.9	£13.3

50% AH: 30% LAR / 70% LSO

		Industrial rents per square foot		
		£10.00	£17.50	£25.00
Residential values per square foot	£550	£0.2	£4.6	£9.1
	£700	£2.1	£6.6	£11.0
	£850	£4.1	£8.5	£12.9

BLV = £5.0m

20% AH: 30% LAR / 70% LSO

		Industrial rents per square foot		
		£10.00	£17.50	£25.00
Residential values per square foot	£550	£0.5	£4.8	£9.1
	£700	£2.8	£7.1	£11.4
	£850	£5.0	£9.3	£13.6

35% AH: 30% LAR / 70% LSO

		Industrial rents per square foot		
		£10.00	£17.50	£25.00
Residential values per square foot	£550	£0.4	£4.7	£9.1
	£700	£2.5	£6.8	£11.2
	£850	£4.6	£8.9	£13.3

50% AH: 30% LAR / 70% LSO

		Industrial rents per square foot		
		£10.00	£17.50	£25.00
Residential values per square foot	£550	£0.2	£4.6	£9.1
	£700	£2.1	£6.6	£11.0
	£850	£4.1	£8.5	£12.9

BLV = £10.0m

20% AH: 30% LAR / 70% LSO

		Industrial rents per square foot		
		£10.00	£17.50	£25.00
Residential values per square foot	£550	£0.5	£4.8	£9.1
	£700	£2.8	£7.1	£11.4
	£850	£5.0	£9.3	£13.6

35% AH: 30% LAR / 70% LSO

		Industrial rents per square foot		
		£10.00	£17.50	£25.00
Residential values per square foot	£550	£0.4	£4.7	£9.1
	£700	£2.5	£6.8	£11.2
	£850	£4.6	£8.9	£13.3

50% AH: 30% LAR / 70% LSO

		Industrial rents per square foot		
		£10.00	£17.50	£25.00
Residential values per square foot	£550	£0.2	£4.6	£9.1
	£700	£2.1	£6.6	£11.0
	£850	£4.1	£8.5	£12.9

Stacked small industrial with adjacent residential

The figures give a graphic illustration of part of the tables on the preceding slide. The dashed lines reflect different BLVs (£2.5m, £5.0m and £10.0m).

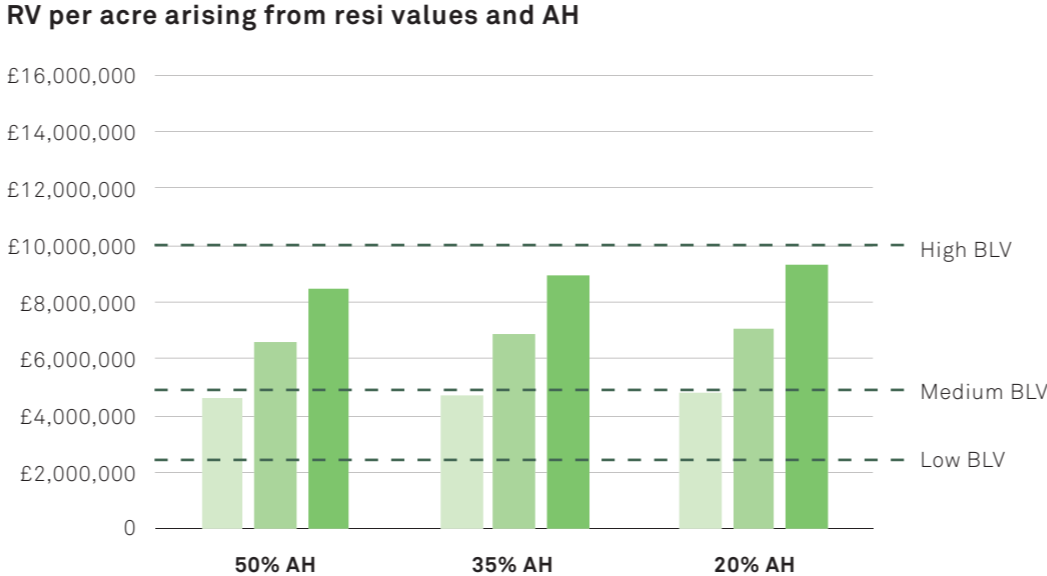

The above figure assumes industrial rents are £17.50/sq.ft

- KEY
- £550/sqft
 - £700/sqft
 - £860/sqft

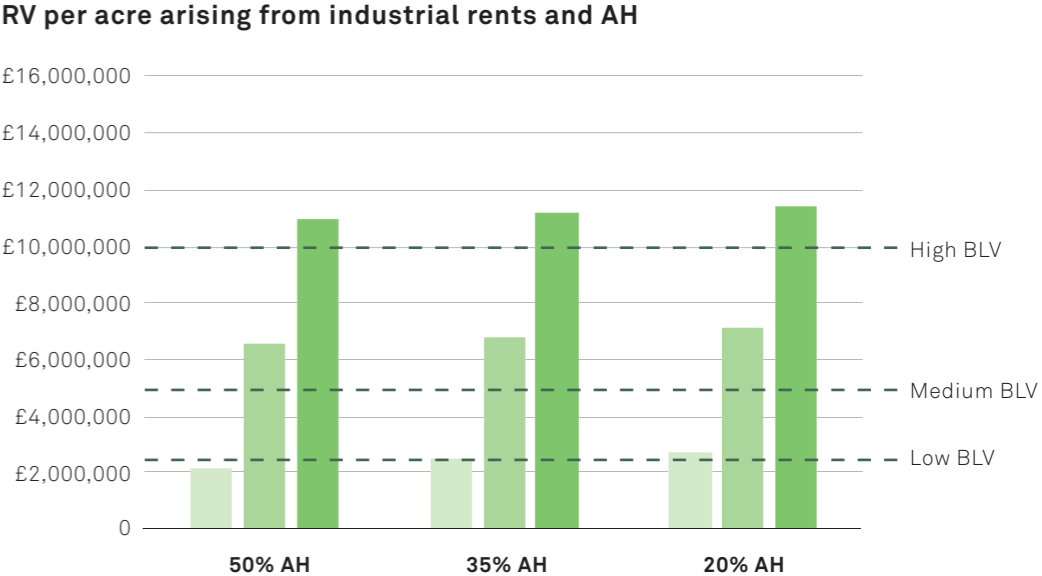

The above figure assumes residential values are £700/sq.ft

- KEY
- £10.00/sqft
 - £17.50/sqft
 - £25.00/sqft

Summary of generalised viability and sensitivity testing

The tables below summarise some of the viability testing presented in the previous slides. They enable a comparison of the viability across the different development typologies by using identical value inputs. It shows the instances in which the three typologies that include a residential element are most likely to be viable.

The upper table shows the instances when each of the four typologies are viable assuming a certain affordable housing level, industrial rents of £17.50 per square feet, residential values of £700 per square foot and a different EUV value.

The lower table presents viability with industrial rents of £25.00 per square foot and residential values of £700 per square foot.

The analysis highlights that the Stacked Medium Industrial with Residential Above generates the most overall value per acre given the same industrial rental values and residential sales values. This is followed closely by the Stacked Workshop/Studio with Residential Above typology.

AH Level	Value Assumptions	BLVs per acre		
		£2.5m	£5m	£10m
50% AH	Industrial Values = £17.50 psf Residential Values = £700 psf	Stacked medium industrial with residential above Stacked workshop / studio with residential above Stacked medium industrial with adjacent residential	Stacked medium industrial with residential above Stacked workshop / studio with residential above Stacked medium industrial with adjacent residential	
35% AH	Industrial Values = £17.50 psf Residential Values = £700 psf	Stacked medium industrial with residential above Stacked workshop / studio with residential above Stacked medium industrial with adjacent residential	Stacked medium industrial with residential above Stacked workshop / studio with residential above Stacked medium industrial with adjacent residential	Stacked medium industrial with residential above
20% AH	Industrial Values = £17.50 psf Residential Values = £700 psf	Stacked medium industrial with residential above Stacked workshop / studio with residential above Stacked medium industrial with adjacent residential	Stacked medium industrial with residential above Stacked workshop / studio with residential above Stacked medium industrial with adjacent residential	Stacked medium industrial with residential above Stacked workshop / studio with residential above

AH Level	Value Assumptions	BLVs per acre		
		£2.5m	£5m	£10m
50% AH	Industrial Values = £25.00 psf Residential Values = £700 psf	Stacked medium industrial with residential above Stacked workshop / studio with residential above Stacked medium industrial with adjacent residential	Stacked medium industrial with residential above Stacked workshop / studio with residential above Stacked medium industrial with adjacent residential	Stacked medium industrial with residential above Stacked workshop / studio with residential above Stacked medium industrial with adjacent residential
35% AH	Industrial Values = £25.00 psf Residential Values = £700 psf	Stacked medium industrial with residential above Stacked workshop / studio with residential above Stacked medium industrial with adjacent residential Stacked large industrial	Stacked medium industrial with residential above Stacked workshop / studio with residential above Stacked medium industrial with adjacent residential	Stacked medium industrial with residential above Stacked workshop / studio with residential above Stacked medium industrial with adjacent residential
20% AH	Industrial Values = £25.00 psf Residential Values = £700 psf	Stacked medium industrial with residential above Stacked workshop / studio with residential above Stacked medium industrial with adjacent residential Stacked large industrial	Stacked medium industrial with residential above Stacked workshop / studio with residential above Stacked medium industrial with adjacent residential	Stacked medium industrial with residential above Stacked workshop / studio with residential above Stacked medium industrial with adjacent residential

6.7 Conclusions

Viability conclusions

The results of the viability analysis show that the schemes for intensified industrial premises are generally commercially attractive under the low and middle BLV scenarios but much less so under the high BLV scenarios.

A caveat to the results is that the rents and yields which were used to establish the BLVs were provided by the GLA and are in our view conservative. Our experience is that yields in the market are currently generally lower and rents generally higher. The rents are more reflective of Outer London locations and/or poorer quality/uneconomic industrial assets. If for example a threshold cost of acquisition and leasehold buy-out of £15m acre was used, which is above the high BLV scenario and may be more representative of prime industrial land together with leasehold buy-out costs, then such schemes are less likely to be commercially attractive.

Broadly higher BLVs in the London context underline the need for investors and developers of intensified industrial premises to identify appropriate sites that could come forward. The sites generally considered for development will more likely have depreciated assets. These will ideally be sites with poor existing provision or underutilised land. Sites that are performing well and that are developed to a high density (such as the Model Site 1 in the study) are less likely to come forward.

The subject sites are likely to have relatively high BLVs because they are densely developed and appear to be operating well. Therefore, these particular sites are less likely to come forward for redevelopment.

One of the challenges to finding suitable sites for redevelopment are that EUVs have increased significantly over the past few years through both rental value uplift and yield compression. The BLVs include the GLA's 20% mark-up to incentivise landowners to make their land available for development. If a developer needs to negotiate the early end of existing longer leaseholds then this could increase the financial threshold for releasing industrial land for redevelopment.

Site scale is important. The subject sites in the study are relatively constrained. Larger sites (of at least 2 hectares) would enable a broader range of design solutions that could create better place making, better operational premises for industrial occupiers, greater mitigation of impacts of the different uses, higher achievable values, better economies of scale and a greater quantum of floorspace to drive values. Residential premises will support value creation but would benefit from a larger quantity of units than those in the scheme which do not reach even 100 units.

The schemes show that value creation is generally equally balanced between the industrial and residential uses. The contribution from the residential elements of the schemes increase as the affordable housing level declines.

Large multi-storey industrial premises are expensive to build (due to the fixed costs associated with the construction of ramps etc) and therefore need to be situated in the right locations. Viability would also be assisted by having a larger net-rentable-area to fixed-cost ratio than what has been used for Model Site 2. 500,000 sf of net rentable area is likely to be more cost efficient than 300,000 sf of net rentable area.

The results from the sensitivity analysis illustrate the commercial attractiveness of the different typologies with different assumptions. Whilst it is difficult to directly compare each of the typologies based on pure viability because site location and development context will determine the most appropriate typological form. However the sensitivity analysis provides a useful framework and starting point to evaluate different potential development opportunities based on a variety of different scheme parameters.

The case for public sector intervention to support the delivery of intensified industrial premises

The results of the viability testing show that the schemes are viable under certain circumstances but unviable under others. Viability is largely dependent upon the residual value (RV) of intensified development being sufficiently above the existing use value (EUV) on the site to incentivise development. The run up in rental values and the compression of investment yields over the past few years have resulted in a significant increase in industrial EUVs. The increase in EUVs makes it less likely for landowners to be adequately incentivised to bring their land forward for redevelopment.

In addition to the increase in EUVs there are a range of other factors that are putting pressure on scheme viability. Intensified industrial premises have relatively high build costs because of the additional structural requirements such as the incorporation of higher levels of floor loading capacity on the upper storeys of industrial premises and where residential accommodation is built above. There is also the proposed policy requirement for affordable housing on designated industrial land of up to 50%.

Another critical factor putting pressure on both viability and project deliverability is the perception of risk associated with a building typology for which there are few existing viable examples in the UK. Actual or perceived risk impacts a range of development considerations that impact scheme deliverability. Developers may need to achieve a higher profit margin (hurdle rate) to compensate for the risk. Lenders may require the developer/ investment partners to commit higher levels of equity into the project or other types of assurances that reduce their own risk exposure. There is also concern about whether the new industrial premises will achieve the required rental levels. There may be insufficient understanding of industrial occupier requirement and doubts as to whether occupiers are willing to forgo traditional industrial formats for one that is untested. And in instances where schemes include a residential element there is the question of whether the accommodation can achieve required sales values or rents.

The difficulty of securing land that has a relatively

low EUV and the presence of the different risk factors that impact viability and deliverability suggest that at least in the short-term there is a degree of market failure. Addressing this market failure by for example demonstrating that intensified formats are viable and successful can be a justification for public sector involvement and investment.

There is a range of options available to help bridge the viability gap and overcome barriers to investment. The public sector could: opt for a light touch; assume an enabling role; or take on a more involved approach that could cover investing its own land, capital and resources. Savills is currently exploring the potential appropriateness and effectiveness of the range of potential options with different private sector players in the sector to get their perspective on how the public sector could most effectively overcome market failures and barriers and facilitate appropriate development.

One light touch approach to support the sector could be the provision of generalised or area-specific planning and design guidance. Given the relatively untested status of intensified industrial premises, such documents could provide some reassurance to potential developers and investors. It could illustrate how development should be undertaken and give assurance that as long as proposed schemes are consistent with the guidance there would be a good likelihood that permission would be granted. Whilst the provision of guidance may help to reduce planning risk it may not adequately address the viability and barriers to investment that would result in development coming forward.

The public sector could opt for a more involved approach in bringing development forward by assuming an more direct enabling role. For example it could make its own land available for development. This would increase the likelihood of delivery whilst limiting its exposure to financial risk. An example could be a conditional sale of its land in which a developer would bring forward agreed industrial intensification buildings. The public sector could also provide loan finance or guarantees which could

help match or underwrite other project finance. This would mean that the public sector would assume a greater financial exposure because of the risk of default. Another option could be for the public sector to subsidise scheme development costs. It could also use its compulsory purchase powers (CPO) to assemble land and make it available for redevelopment in a manner consistent with a development framework. It could also work towards bringing together different disparate potential parties (for example industrial developers/operators and residential developer/operators) who have little experience in working together.

The public sector could opt for a more hands-on role is which it assumes significantly greater financial risk. It could develop its own land and contract out the construction whilst maintaining ownership and management. It could also acquire sites which it could then develop on its own or with development partners. It could also take the lead on development in concert with joint venture partners and share the risks and profits or be a more passive investor.

There is a wide range of options available to the public sector with a variety of associated risks and rewards. It will need to carefully consider the role it wishes to play to support the establishment of the sector for intensified industrial premises. It could opt for a limited role although this may not result in sufficient schemes coming forward. Alternatively it could also opt for a more robust role which would increase the likelihood that schemes come forward but this would mean that it assumes a greater level of risk.

WE MADE THAT LLP
Unit 21 Tower Workshops
58 Riley Road
London SE1 3DG

T +44 (0)20 7252 3400
www.wemadethat.co.uk
studio@wemadethat.co.uk

We Made That LLP is
registered in England &
Wales. Reg no. OC367789

APPENDICES

A Market Stakeholder Feedback

B Build costs

C Structural Guidance

Market stakeholder feedback

Challenges of intensification

- Sense that multi-level accommodation may not suit all occupiers
- Market is still conservative in its views on intensification
- Businesses are moving out of the M25 due to availability, this may still be preferable to 'substandard' accommodation
- Industrial market is going strong, but interest from residential developers appears to be slowing - the difference between industrial and residential land values has narrowed
- The 'no net loss' policy of the London Plan will force the issue of intensification, in addition to market conditions

Planning policy

- Concern about yard area provided with 65% plot ratio from developers of big box space - feeling that this will fore 'substandard' provision
- 65% plot ratio can work for the smaller sites, many are already at or higher than this
- Concern about existing 'substandard' site that have higher plot ratios than 65% - 'no net loss' restricts ability to redevelop e.g. under provision of yard space
- Masterplans showing residential in SIL areas may increase 'hope' values
- Concern over relationship between CIL/S106 cost and increase job numbers

Smaller sites

- Do not typically require HGV access to each unit
- Could have shared area for HGVs
- Above 2,500sqf would require goods lift
- Smaller sites will still need some yard space

Multi storey large industrial

- Ramped multi-level industrial works economically on a 2.8ha (7 acre) site - spiral ramps require larger sites
- Units larger than 280sqm (3,000sqft) would likely use a ramp not goods lifts
- Any unit larger than 2,300sqm (25,000sqft)

should have dock levellers

- Residential could allow cross subsidy of industrial
- Multi-level warehouse with ramps would be possible Park Royal

Residential and industrial

- Concern from insurers for the residential units - Albert Wharf did not proceed due to concerns about fire from insurers
- Industrial space must be able to operate 24/7 - need to consider noise
- 'Agent of change' principle may not address this - where development is mixed use from the outset
- May require all windows to be non-openable to avoid nuisance issues

Delivery

- Multi-storey would require a significant pre-let to reduce risk
- Needs to be high quality exemplar project built - role for public sector led demonstrator
- Funds have a criteria for investing
- Consider the loss of income to a site owner during re-development
- A PRS model could work for the delivery of residential due to lesser impact on value than market sale program

Model site 2

- Ramps have significant construction cost
- Straight ramps preferred as they are more cost effective
- Foundation costs may become prohibitive for + 2 storeys

Model site 1

- 95% plot ratio could lead to compromised industrial operations
- HGVs manoeuvring and reversing on a highway could be a problem
- Deck over yard space - encapsulate noise and mitigate nuisance

Model site 3

- Recommend a single building without the cut out loading areas - design amended accordingly
- HGV access not required for all units

APPENDIX B

BUILD COSTS

Cost plans were undertaken for each of the four model site schemes. A summary of the results is included opposite.

A number of additional cost planning rates have been considered. These include structural uplifts associated with increasing floor loadings of industrial space and construction uplifts associated with acoustic mitigation between industrial and residential uses.

Typical Build Costs

Model Site 1a	£1224.14 per sqm £97.14 per sqft
Model Site 1b	£1505.24 per sqm £109.12 per sqft
Model Site 2	£1846.39 per sqm £182.38 per sqft
Model Site 3	£1194.64 per sqm £97.79 per sqft

Small industrial structural uplifts

- 7.5kN/m2 UDL floor loading £9,200,000 - £139.84/ft2
- 15 kN/m2 UDL floor loading £11,000,000 - £167.20/ft2 (+20%)
- 25 kN/m2 UDL floor loading £12,000,000 - £182.40/ft2 (+30%)

Large industrial structural uplifts

- 7.5kN/m2 UDL floor loading £52,000,000 - £182.38/ft2
- 35 kN/m2 UDL floor loading £63,000,000 - £220.96/ft2 (+21%)
- 50 kN/m2 UDL floor loading £95,000,000 - £333.20/ft2 (+83%)

Non-opening windows

- Non-opening windows produce a saving of £30/m2 of the glazed area
- Mechanical ventilation is an extra over cost of circa £50/m2 of the area

Triple glazing

- Triple glazing is circa £120/m2 addition to the glazed area

Winter gardens

- Winter gardens estimated cost is dependent on size and specification
- Suggested budget allowance of £1500 - £2000/m2

Increased wall and floor build-ups

- Increased wall build up is estimated at £125/m2
- Increased floor is estimated at £145/m2

Acoustic fences

- Acoustic fences are typically minimum 4m high and cost plan rate is £280/m

APPENDIX C
STRUCTURAL
GUIDANCE

Workshop / studios

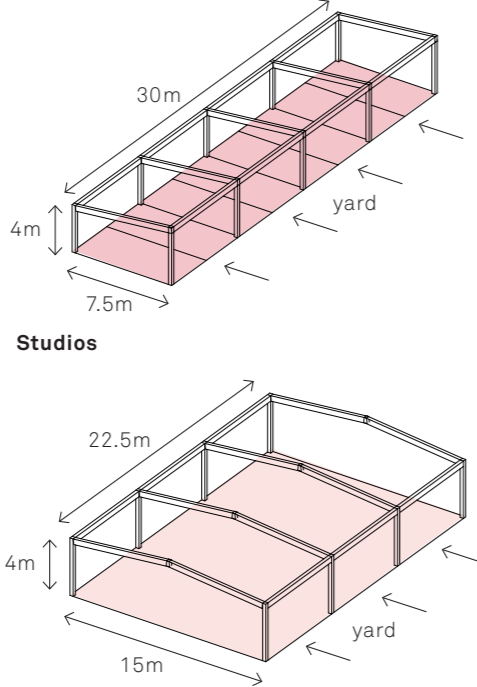
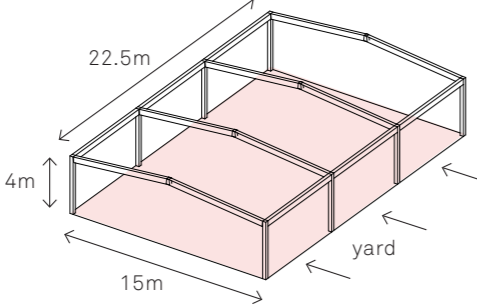
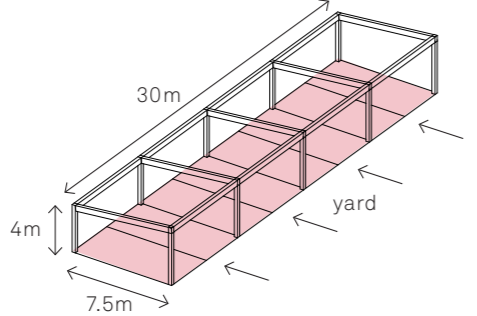
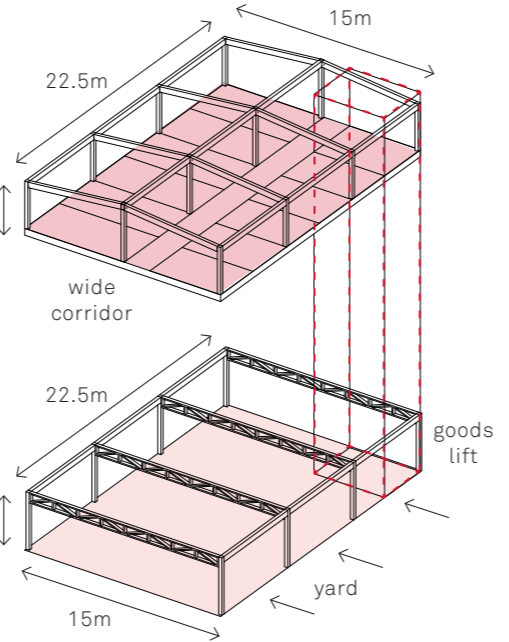
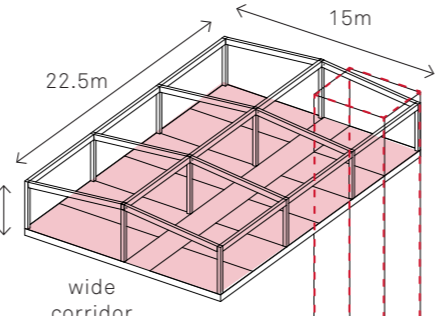
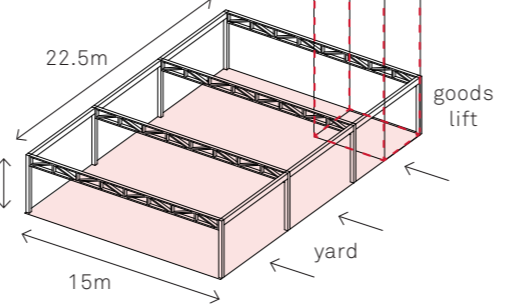
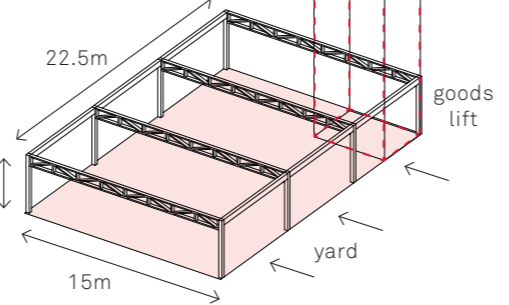
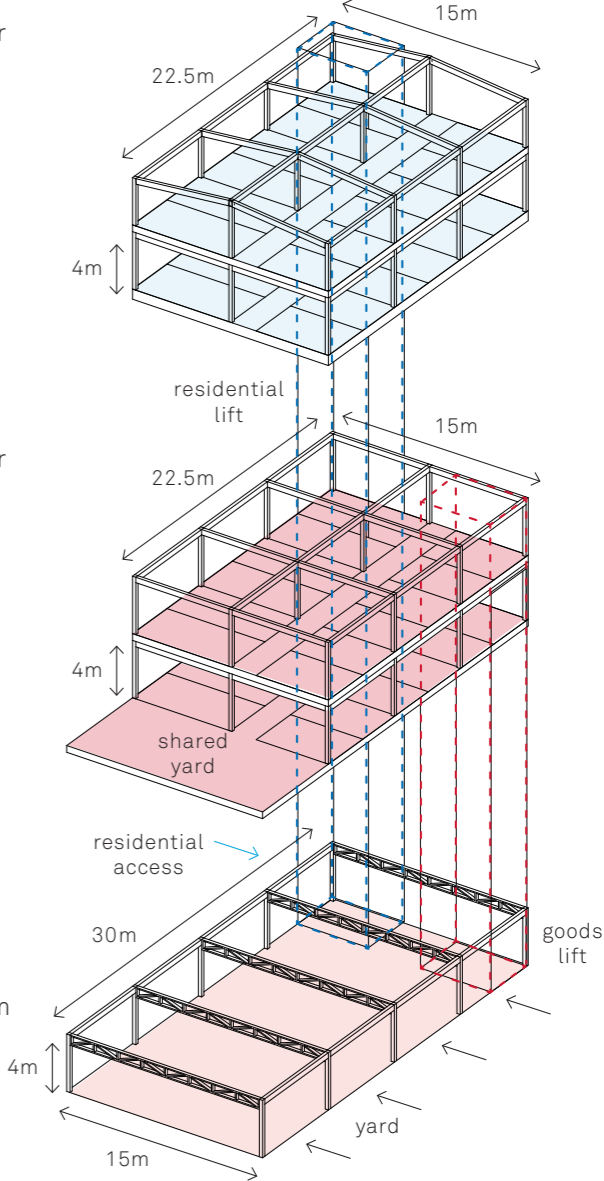
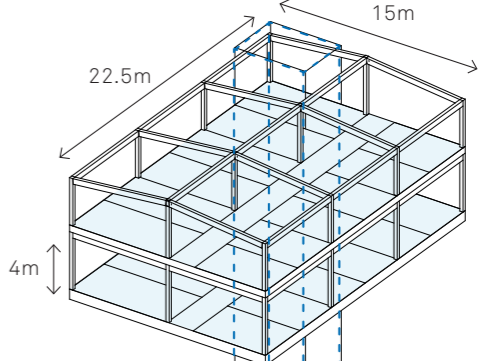
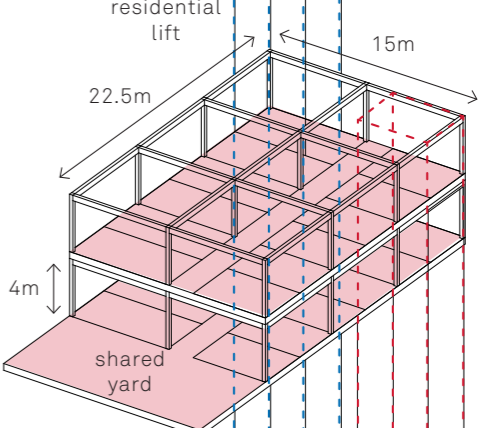
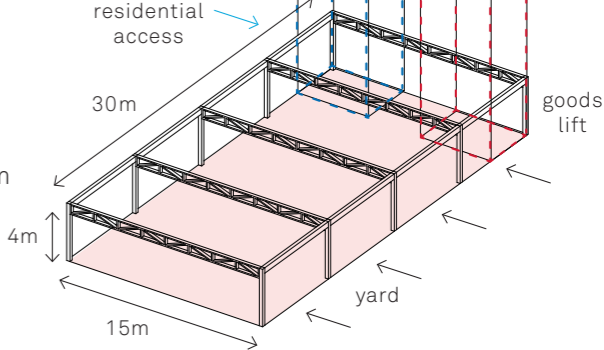
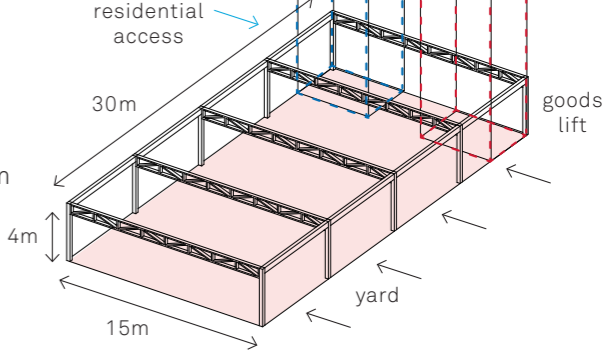
	General design requirements	Additional stacked industrial requirements	Additional mixed industrial-residential requirements
<p>Structural approach</p>	<p>Studios</p> <ul style="list-style-type: none"> — Steel portal frame to roof, primary rolled sections approx. 375mm dp. — OR glulam beam approx. 535mm dp. — Ground bearing/suspended RC slab — Approximate steel tonnage: 45 kg/m² <p>Workshops</p> <ul style="list-style-type: none"> — Steel portal frame to roof, primary rolled sections approx. 750mm dp. — OR cellular beam 875mm dp. — OR glulam beam approx. 1075mm dp. — Ground bearing/suspended RC slab — Approximate steel tonnage: 45 kg/m²  <p>Studios</p>  <p>Workshops</p> 	<p>Upper level studios</p> <ul style="list-style-type: none"> — Steel portal frame to roof, primary rolled sections approx. 375mm dp. — OR cellular beam 450mm dp. — Composite deck floor approx. 140mm dp. for 3.75m span. — Primary rolled sections approx. 375mm dp. — OR RC beam & block floor approx. 155mm dp. for 3.75m span — OR RC precast hollowcore floor planks approx. 200mm dp. for 7.5m span — Approximate steel tonnage: 50 kg/m² <p>Lower level workshops</p> <ul style="list-style-type: none"> — Steel portal frame, primary rolled sections approx. 900mm dp — OR primary truss section approx. 1000mm dp — OR addition of a central column reduces truss depth to 500mm or rolled section depth to 375mm — Ground bearing/suspended RC slab — Approximate steel tonnage: 90 kg/m²  <p>Upper level studios</p>  <p>Lower level workshops</p>  <p>Combined studios and workshops</p> 	<p>Upper level residential</p> <ul style="list-style-type: none"> — Steel braced frame, primary rolled sections approx. 375mm dp. — OR RC frame, primary beam approx. 350mm dp. if central column adopted down to ground level — Composite deck floor approx. 140mm dp. for 3.75m span. — Primary rolled sections approx. 375mm dp. — OR RC beam & block floor approx. 155mm dp. for 3.75m span — OR timber infill floor joists approx. 175mm dp. for 3.75m span. — Primary rolled sections approx. 375mm dp. — Approximate steel tonnage: 50 kg/m² — Possibility for timber frame <p>Upper level studios</p> <ul style="list-style-type: none"> — Steel braced frame, primary rolled sections approx. 375mm dp. — Composite deck floor approx. 140mm dp. for 3.75m span. — Primary rolled sections approx. 375mm dp. — OR RC beam & block floor approx. 155mm dp. for 3.75m span — OR RC precast hollowcore floor planks approx. 200mm dp. for 7.5m span — OR RC frame option, primary beam approx. 350mm dp. if central column adopted down to ground level — Approximate steel tonnage: 65 kg/m² <p>Lower level workshops</p> <ul style="list-style-type: none"> — Steel portal frame, primary rolled sections approx. 1400mm dp. — OR primary truss section approx. 1500mm dp. — OR RC frame option if central column adopted down to ground level, primary beam approx. 350mm dp. — Ground bearing/suspended RC slab — Approximate steel tonnage: 105 kg/m²  <p>Upper level residential</p>  <p>Upper level studios</p>  <p>Lower level workshops</p>  <p>Combined studios, workshops and residential</p> 

Small industrial specification

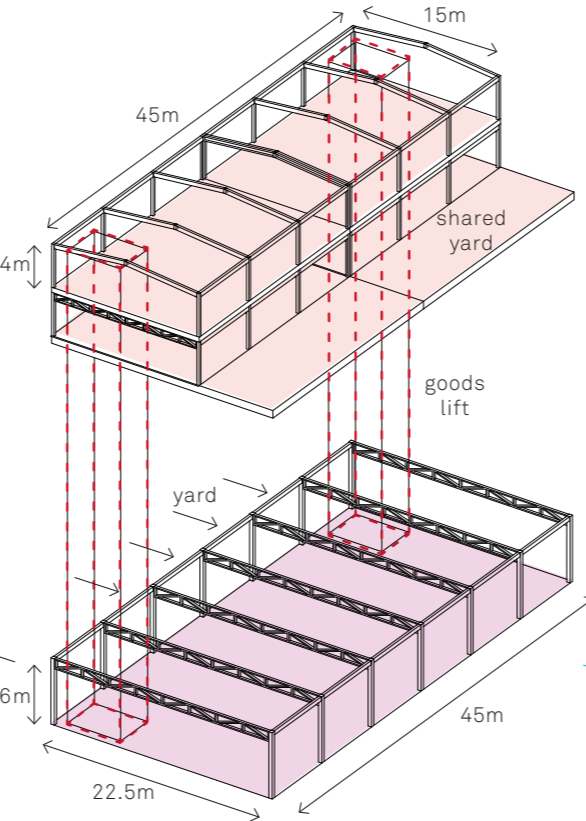
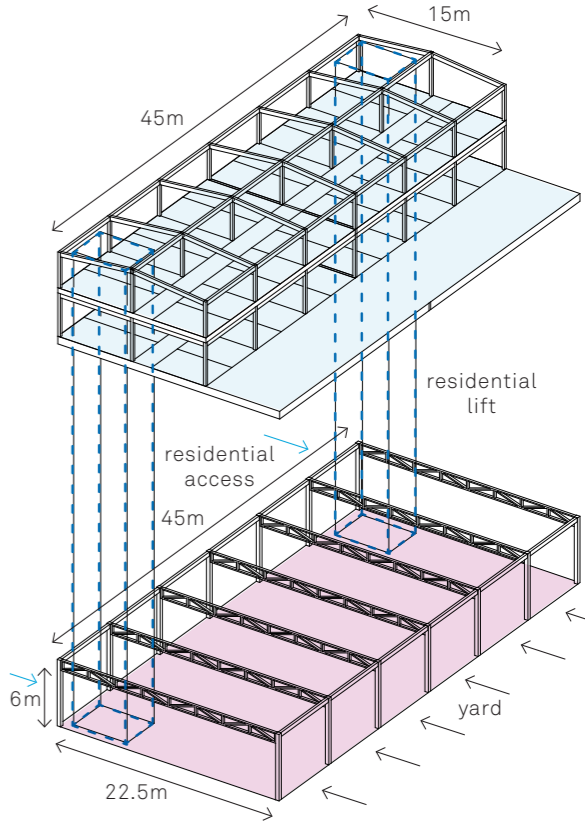
	General design requirements	Additional stacked industrial requirements	Additional mixed industrial-residential requirements
Structural approach	<p>Small industrial</p> <ul style="list-style-type: none"> — Steel portal frame to roof, primary rolled sections approx. 1125mm dp. — <i>OR</i> Cellular beam 1300mm dp. — Ground bearing/suspended RC slab — Approximate steel tonnage: 55 kg/m² 	<p>Upper level workshops</p> <ul style="list-style-type: none"> — As workshops and studios — Shared yard assumed to adopt same live loading as internal workshop — Approximate steel tonnage: 65 kg/m² <p>Lower level small industrial</p> <ul style="list-style-type: none"> — Steel portal frame, primary truss section approx. 1700mm dp. — <i>OR</i> addition of a 2/3 column reduces truss depth to 1000mm — Ground bearing/suspended RC slab — Live loading governed by ground bearing/suspended slab capacity, same loading as per single storey option — Approximate steel tonnage: 90 kg/m²  <p>Combined small industrial and workshops</p>	<p>Upper level residential</p> <ul style="list-style-type: none"> — Steel braced frame, primary rolled sections approx. 375mm dp. — <i>OR</i> RC frame, primary beam approx. 350mm dp. if central column adopted down to ground level — Composite deck floor approx. 140mm dp. for 3.75m span. — Primary rolled sections approx. 375mm dp. — <i>OR</i> RC beam & block floor approx. 155mm dp. for 3.75m span — <i>OR</i> timber infill floor joists approx. 175mm dp. for 3.75m span. — Primary rolled sections approx. 375mm dp. — Approximate steel tonnage: 50 kg/m² — Possibility for timber frame <p>Lower level small industrial</p> <ul style="list-style-type: none"> — Steel portal frame, primary truss section approx. 1700mm dp. — <i>OR</i> addition of a 2/3 column reduces truss depth to 1000mm — Ground bearing/suspended RC slab — Live loading governed by ground bearing/suspended slab capacity, same loading as per single storey option — Approximate steel tonnage: 90 kg/m²  <p>Combined small industrial and residential</p>

Medium industrial
specification

	General design requirements	Additional stacked industrial requirements	Additional mixed industrial-residential requirements
<p>Structural approach</p>	<p>Medium industrial</p> <ul style="list-style-type: none"> — Steel portal frame to roof, primary cellular sections approx. 2150mm dp. — OR primary truss section approx. 2500mm dp. — Ground bearing/suspended RC slab — Approximate steel tonnage: 65 kg/m² 	<p>Upper level small industrial</p> <ul style="list-style-type: none"> — Steel portal frame to roof as single storey option above — Composite deck floor approx. 140mm dp. for 3.75m span. — OR RC beam & block floor approx. 225mm dp. for 3.75m span — OR RC precast hollowcore floor planks approx. 250mm dp. for 7.5m span — Approximate steel tonnage: 65 kg/m² <p>Lower level medium industrial</p> <ul style="list-style-type: none"> — Steel braced frame, primary cellular sections approx. 2100mm dp. — OR primary truss section approx. 2600mm dp. — Ground bearing/suspended RC slab — Approximate steel tonnage: 105 kg/m² 	<p>— NOTE: The rules of thumb methodology adopted for the other options cannot be applied to this more complicated structure.</p>

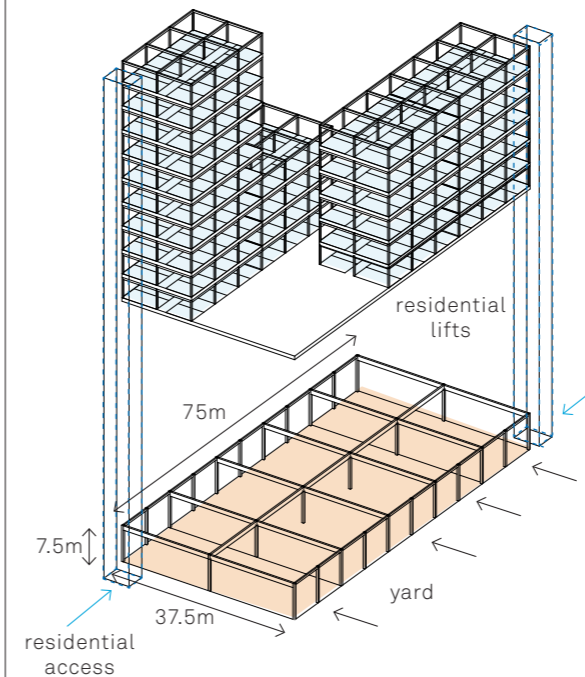
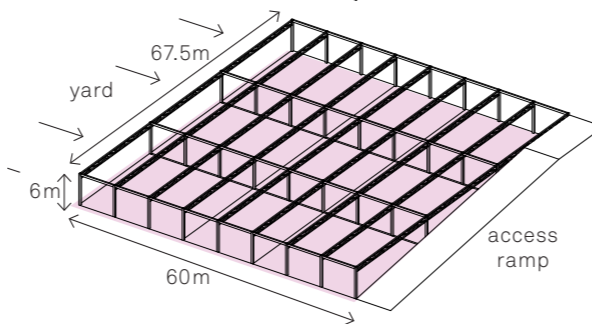
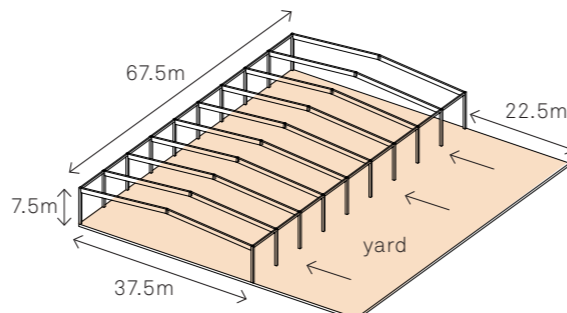
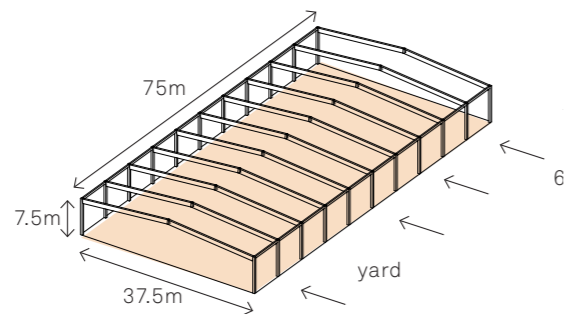

Large industrial specification

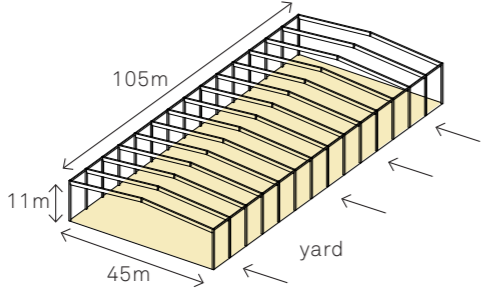
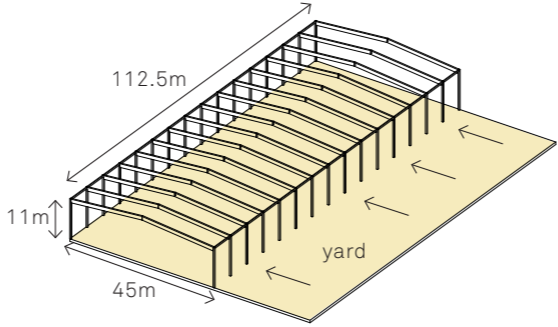
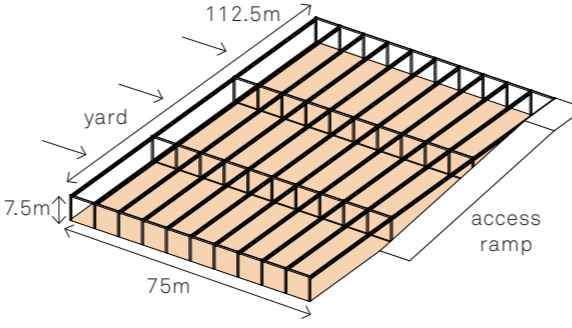
	General design requirements	Additional stacked industrial requirements	Additional mixed industrial-residential requirements
Structural approach	<p>Large industrial</p> <ul style="list-style-type: none"> — Steel portal frame to roof, primary cellular sections approx. 2575mm dp. — OR primary truss section approx. 3000mm dp. — Ground bearing/suspended RC slab — Approximate steel tonnage: 70 kg/m² 	<p>Upper level medium industrial</p> <ul style="list-style-type: none"> — Steel portal frame to roof as single storey option above — Composite deck floor approx. 140mm dp. for 3.75m span. — OR RC beam & block floor approx. 225mm dp. for 3.75m span — OR RC precast hollowcore floor planks approx. 250mm dp. for 7.5m span — Approximate steel tonnage: 70 kg/m² <p>Lower level medium industrial</p> <ul style="list-style-type: none"> — Steel braced frame, primary cellular sections approx. 3700mm dp. — OR truss section approx. 4500mm dp. — Ground bearing/suspended RC slab — Approximate steel tonnage: 135 kg/m²  	<ul style="list-style-type: none"> — The rules of thumb methodology adopted for the other options cannot be applied to this more complicated structure 